

# Eisenbahn-Prellbock MOC aus Lego-Elementen

Bauanleitung nach Lego Digital Designer

© made by Sebastian P., D-24631, Germany, 2014, Vers 1

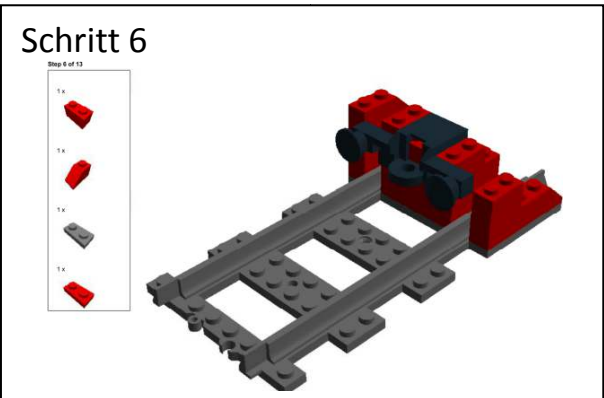
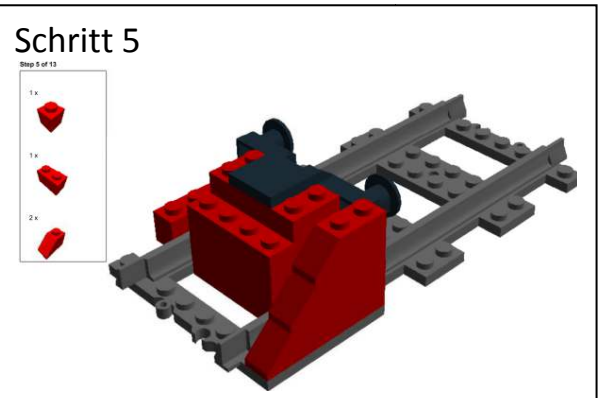
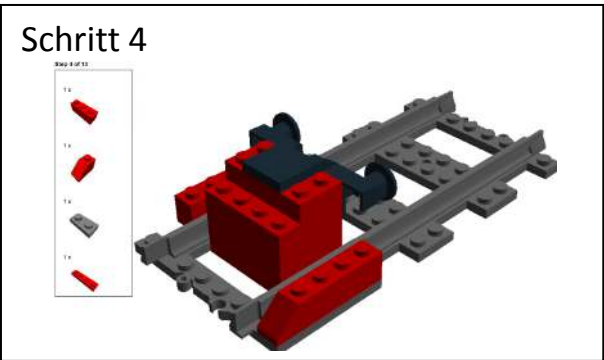
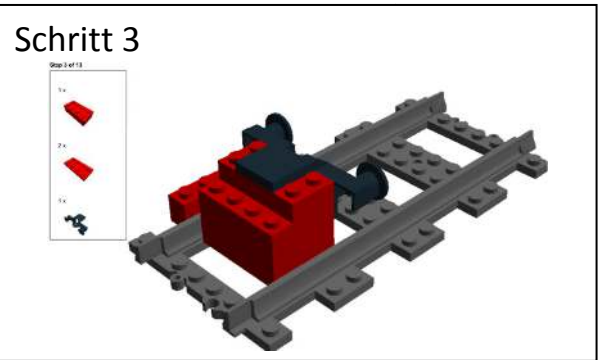
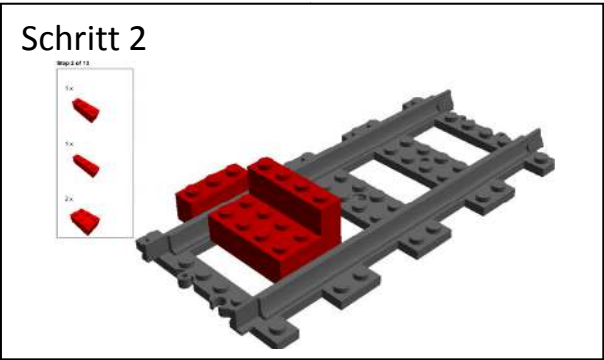
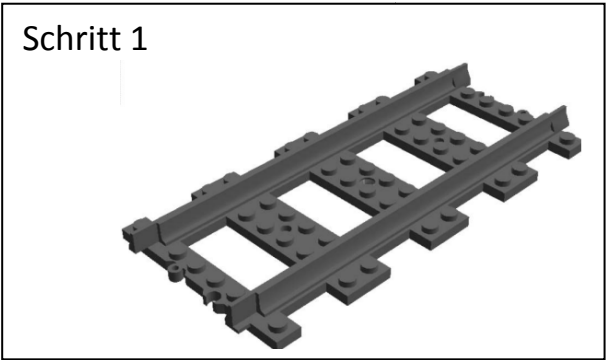
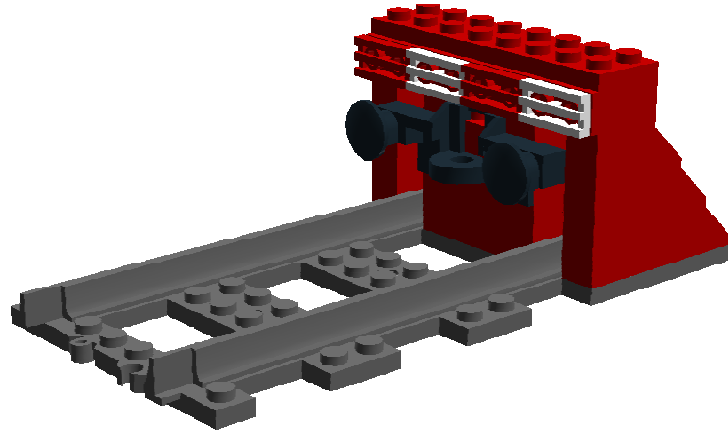

### Schritt 7

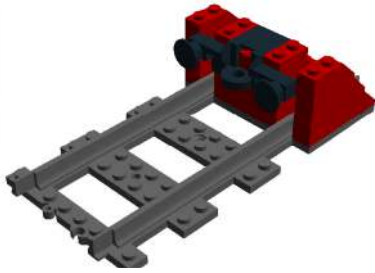
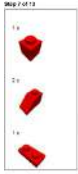

### Schritt 8

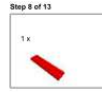

### Schritt 9

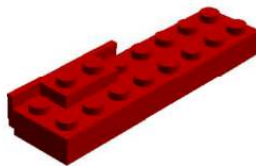
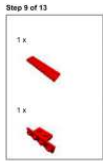

### Schritt 10

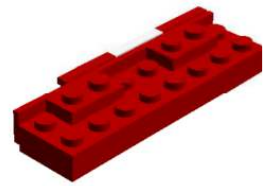
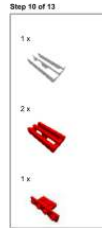

### Schritt 11

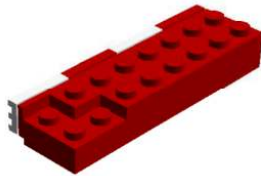
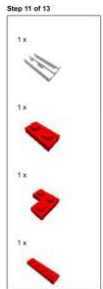

### Schritt 12

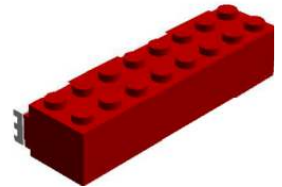
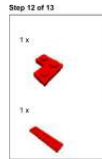

### Schritt 13

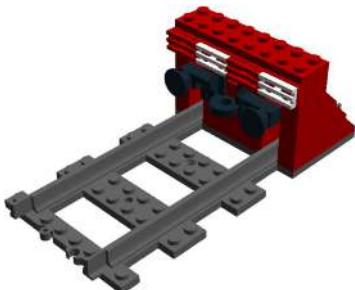

# Eisenbahn-Prellbock MOC aus Lego-Elementen

## Stückliste

2 x  300521 BRICK 1X1 - Klares Rot

2 x  300421 BRICK 1X2 - Klares Rot

2 x  362221 BRICK 1X3 - Klares Rot

1 x  301021 BRICK 1X4 - Klares Rot

2 x  300221 BRICK 2X3 - Klares Rot

1 x  300121 BRICK 2X4 - Klares Rot

6 x  304021 ROOF TILE 1X2/45° - Klares Rot

2 x  241201 RADIATOR GRILLE 1X2 - Weiss

2 x  241221 RADIATOR GRILLE 1X2 - Klares Rot

2 x  4211063 PLATE 1X2 - Dunkel Steingrau

3 x  302321 PLATE 1X2 - Klares Rot

2 x  242021 CORNER PLATE 1X2X2 - Klares Rot

2 x  371021 PLATE 1X4 - Klares Rot

2 x  302021 PLATE 2X4 - Klares Rot

3 x  303421 PLATE 2X8 - Klares Rot

2 x  243621 ANGLE PLATE 1X2/1X4 - Klares Rot

1 x  402226 BUFFER/CLUTCH - Schwarz

1 x  4279713 RAIL STRAIGHT 16 M - Dunkel Steingrau