

 DIGITAL DESIGNER 4.2

Model Name:
THW MLW
Mannschaftslastwagen Typ I
Number of Bricks: 264

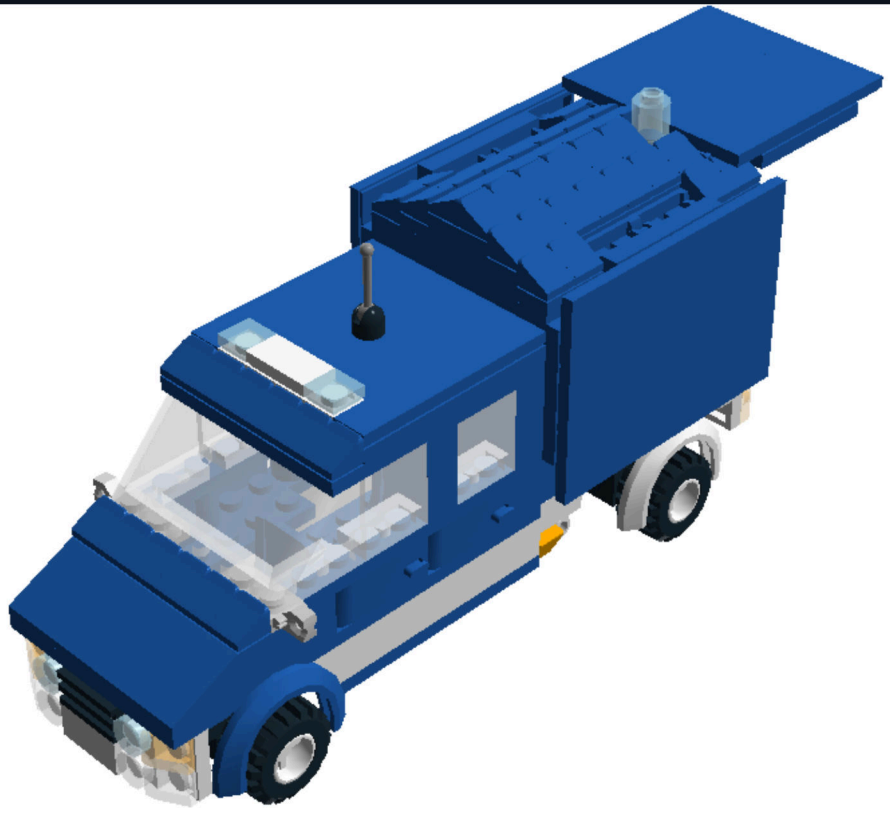

Step 1 of 91

1 x



1 x



Step 2 of 91

1 x



1 x



1 x



Step 3 of 91



Step 4 of 91



Step 5 of 91

1 x



1 x



Step 6 of 91

1 x



1 x



1 x

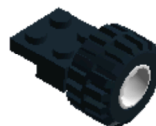

Step 7 of 91



Step 8 of 91





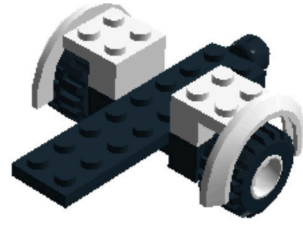
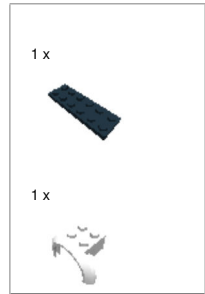

Step 9 of 91

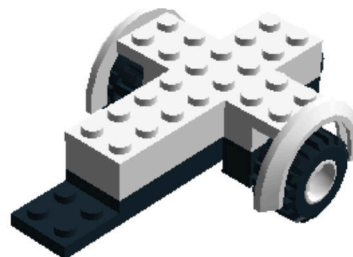
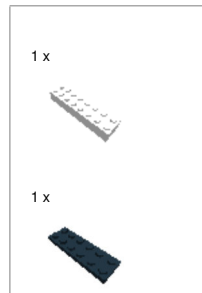

Step 10 of 91



Step 11 of 91

- 1 x 
- 1 x 
- 1 x 
- 1 x 

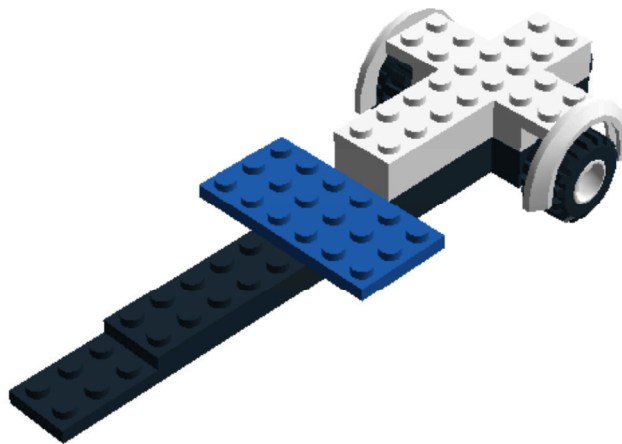

Step 12 of 91

1 x



1 x



1 x



1 x

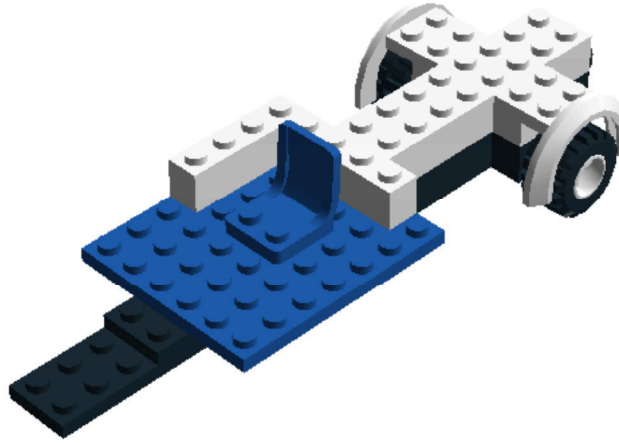

Step 13 of 91

2 x



1 x



1 x

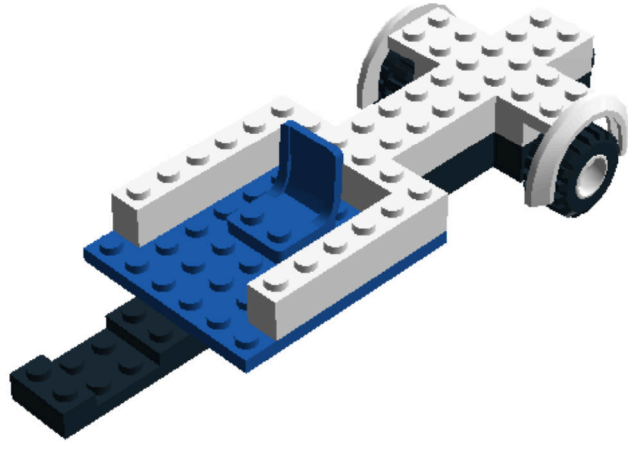

Step 14 of 91

1 x



1 x



1 x

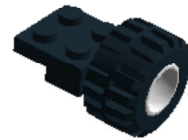

Step 15 of 91

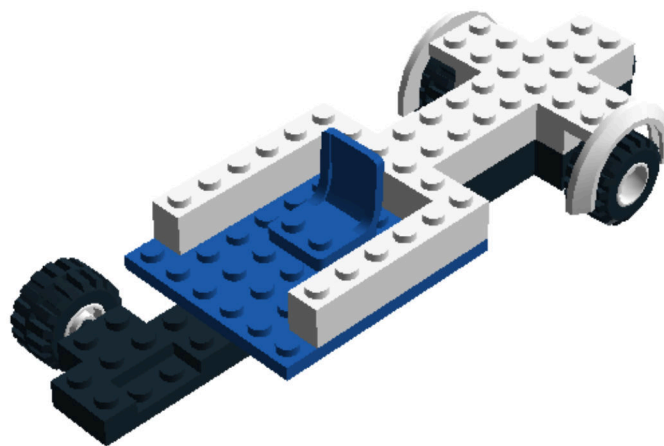

Step 16 of 91

1 x



1 x



1 x



Step 17 of 91

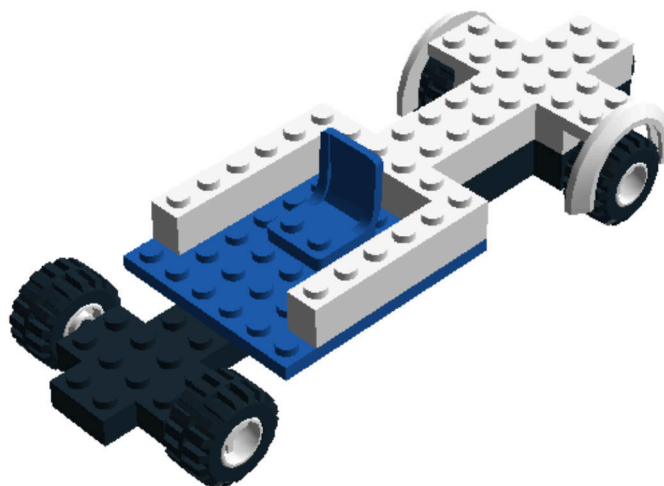

Step 18 of 91

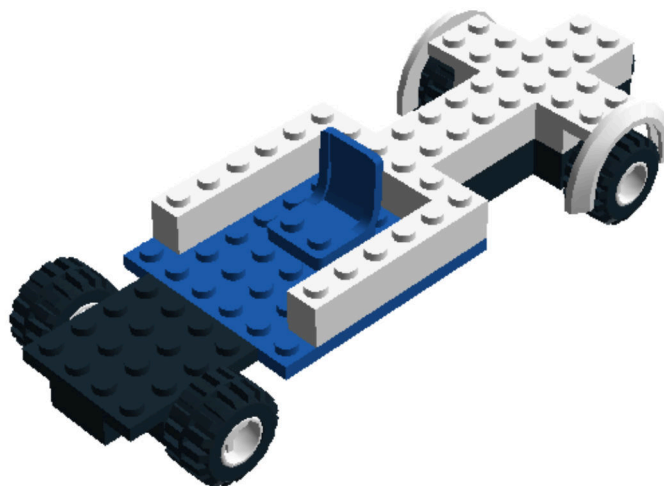

Step 19 of 91

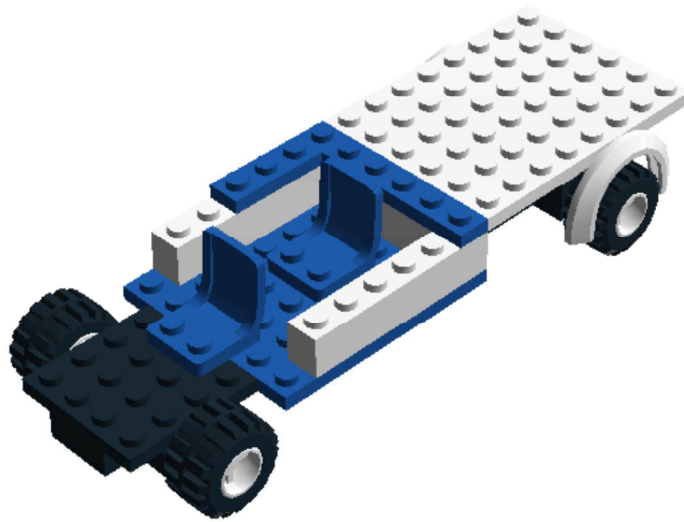
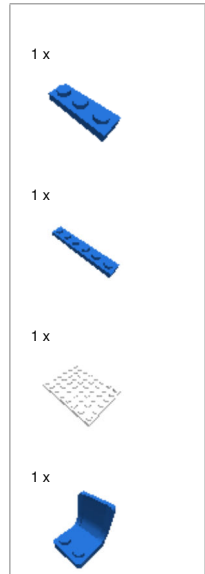

Step 20 of 91

1 x



1 x



1 x



1 x

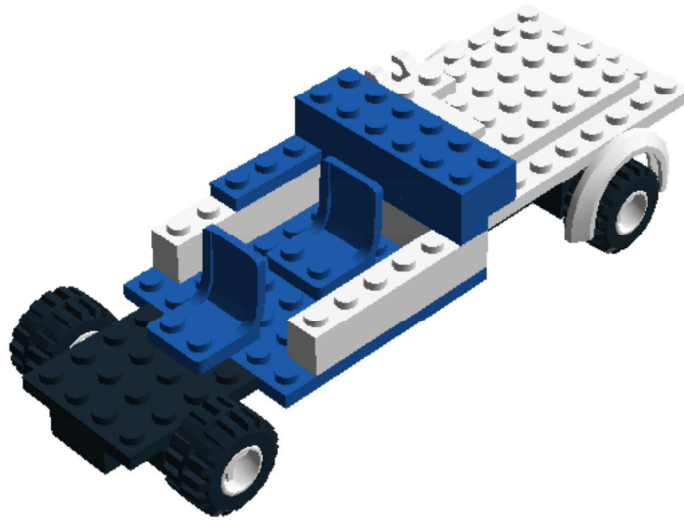

Step 21 of 91

1 x



1 x



1 x



1 x

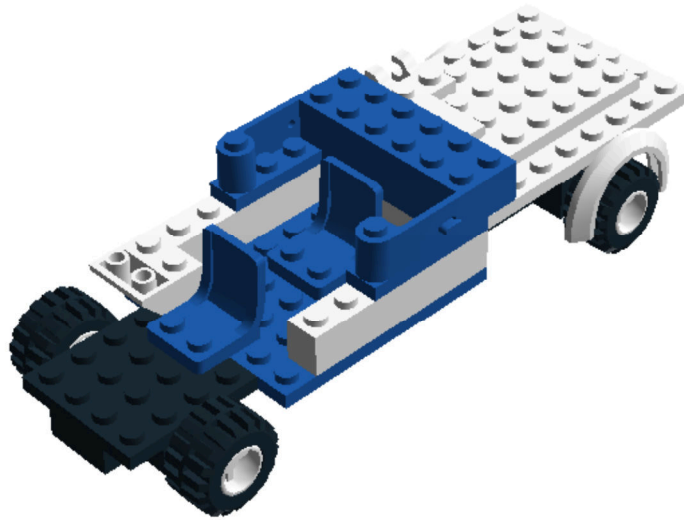

Step 22 of 91

1 x







1 x

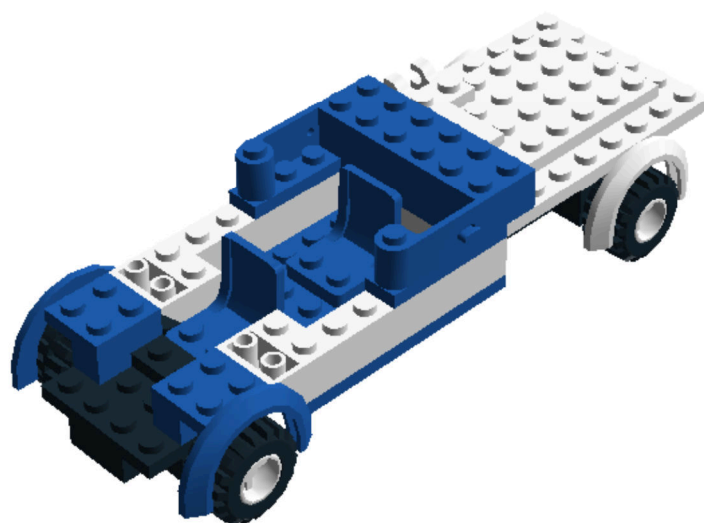

2 x



Step 23 of 91

- 1 x 
- 1 x 
- 1 x 
- 1 x 

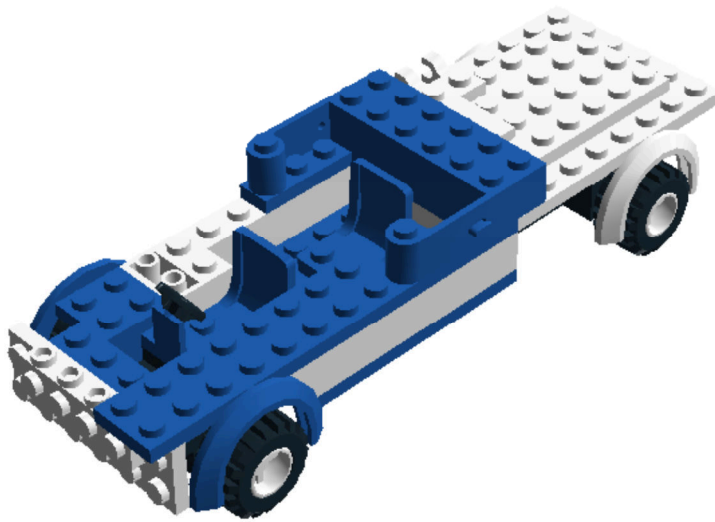

Step 24 of 91

1 x



1 x



1 x



1 x

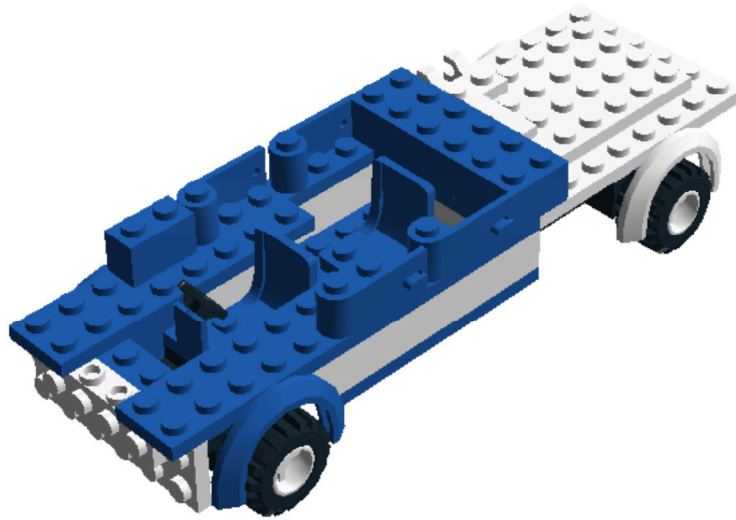

Step 25 of 91

1 x



2 x



1 x

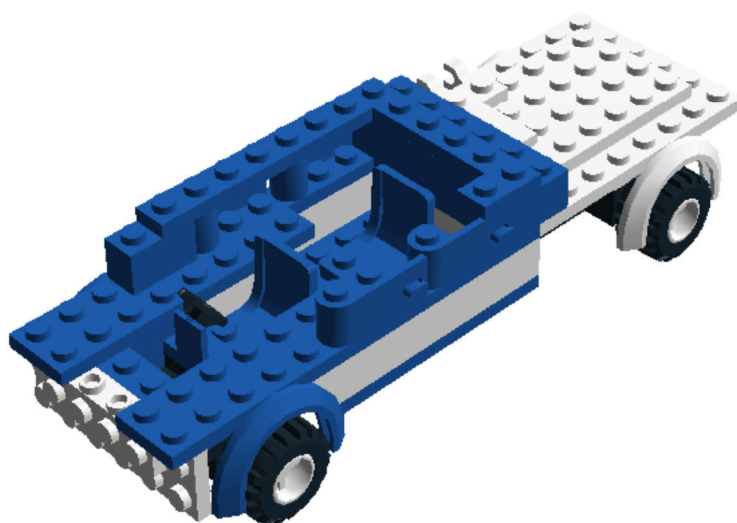

Step 26 of 91

2 x



2 x

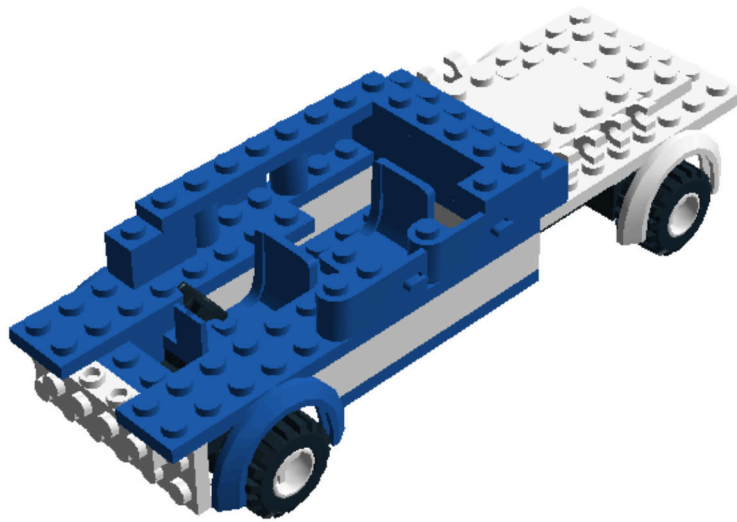

Step 27 of 91

2 x



1 x



1 x

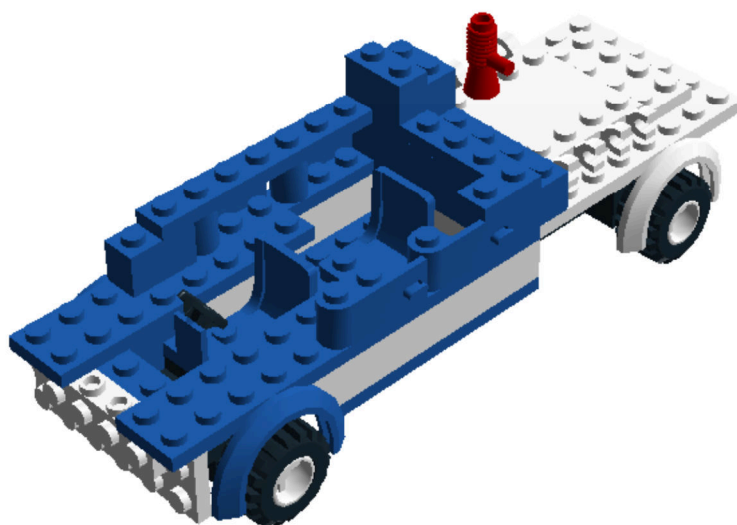

Step 28 of 91

1 x



2 x



1 x

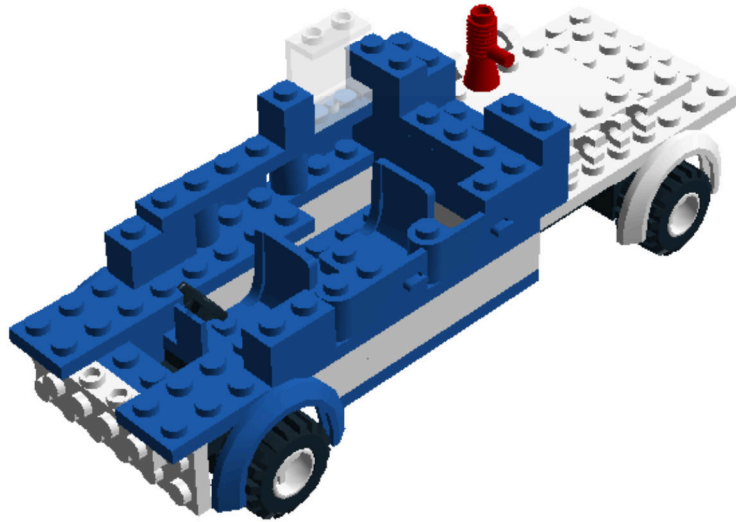

Step 29 of 91

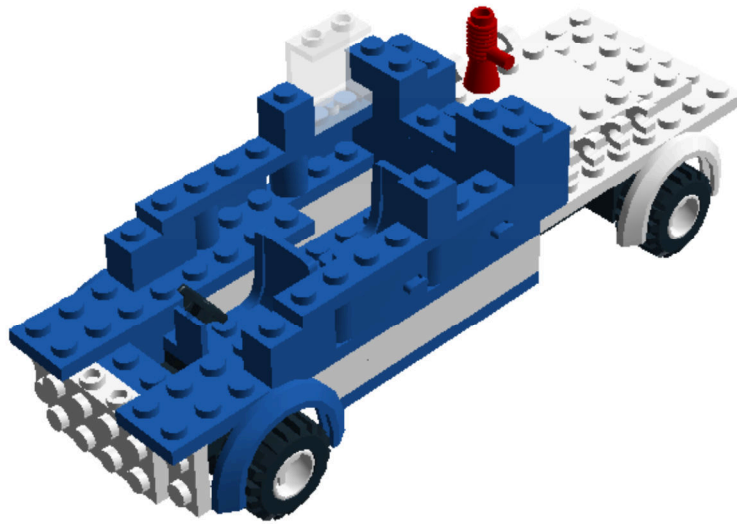
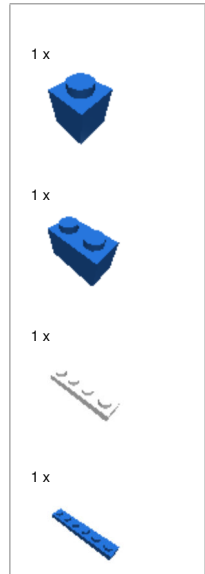

Step 30 of 91

1 x



1 x



2 x

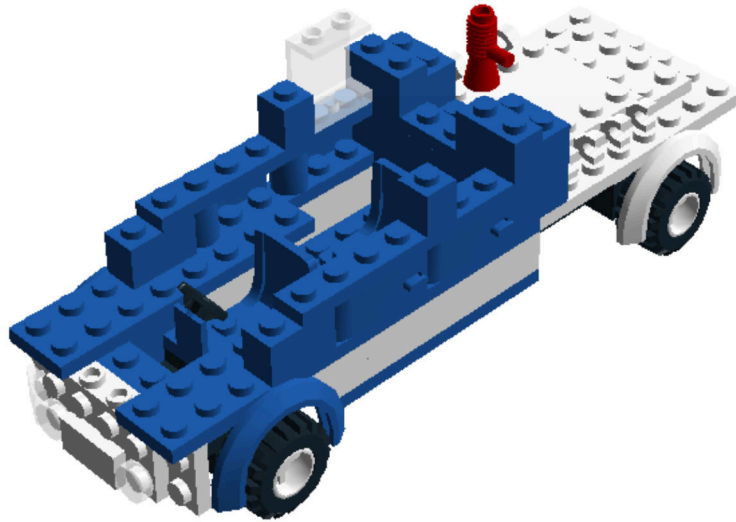

Step 31 of 91

1 x



2 x



1 x

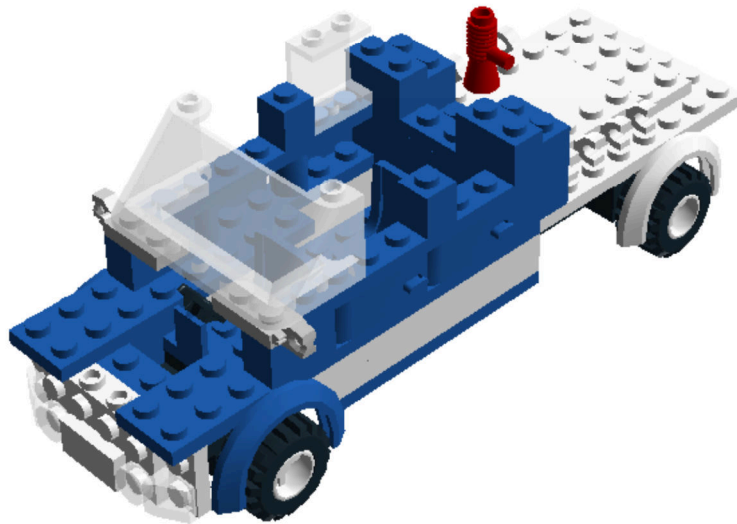

Step 32 of 91

1 x



1 x



2 x

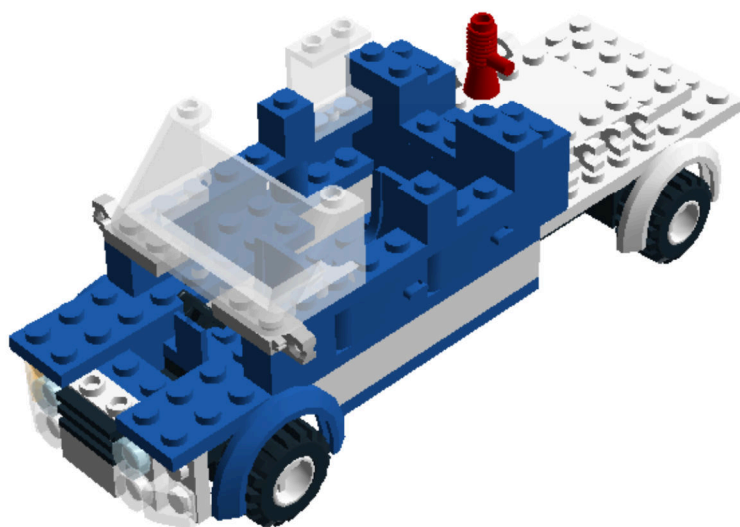

Step 33 of 91

1 x



1 x



2 x

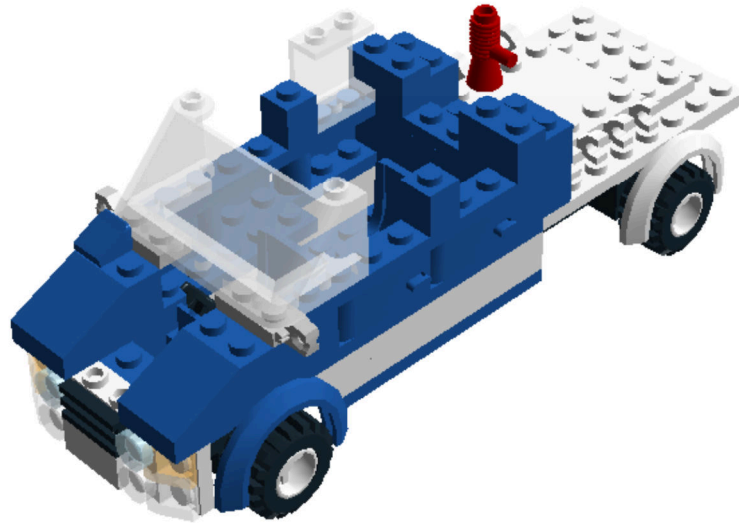

Step 34 of 91

3 x



1 x

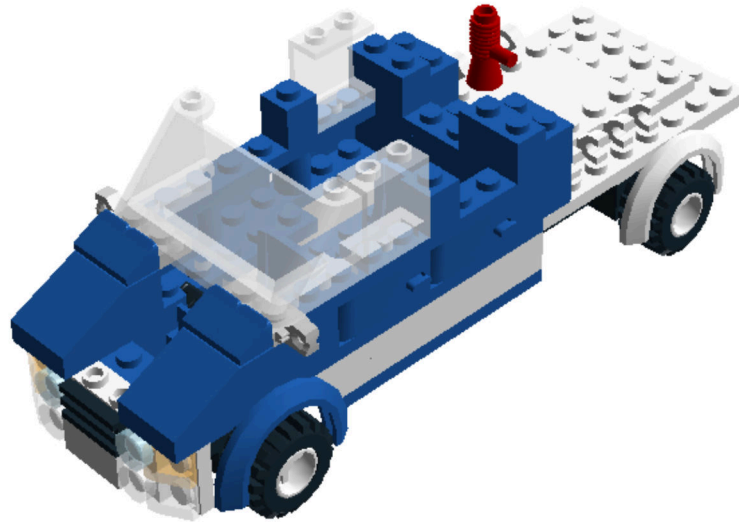

Step 35 of 91

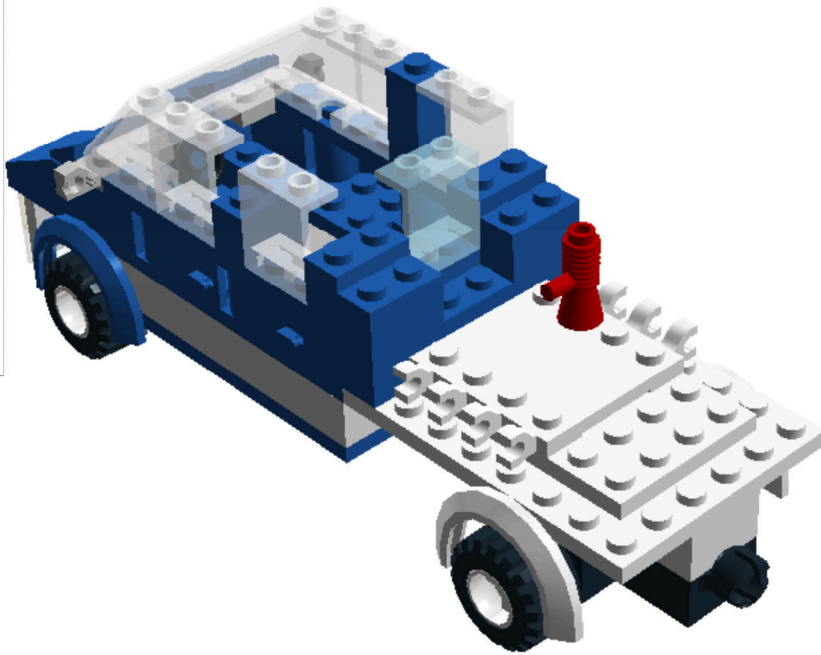
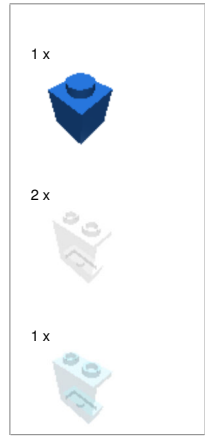



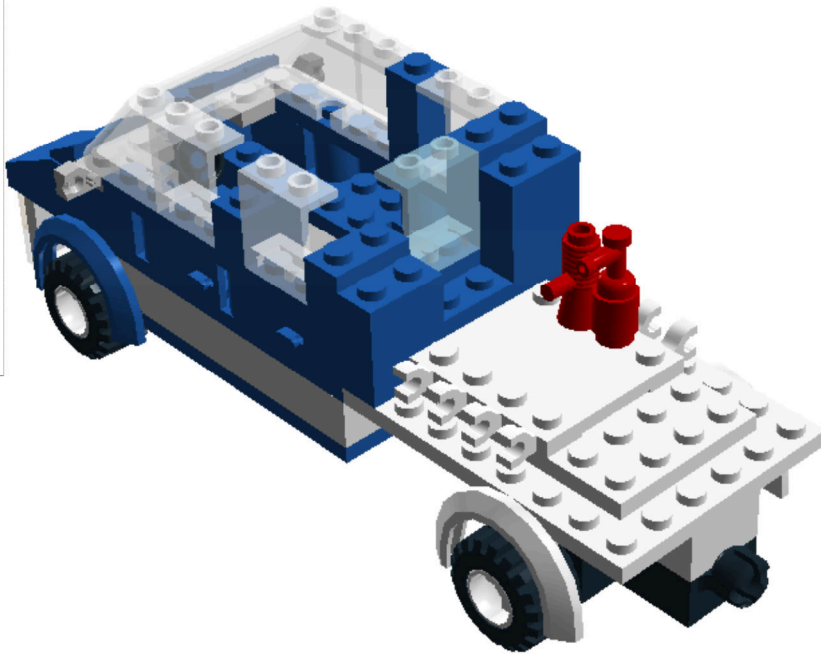
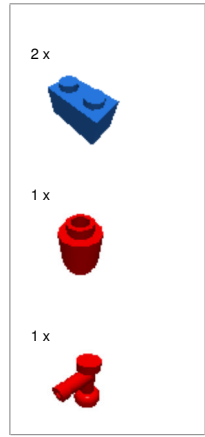

Step 36 of 91

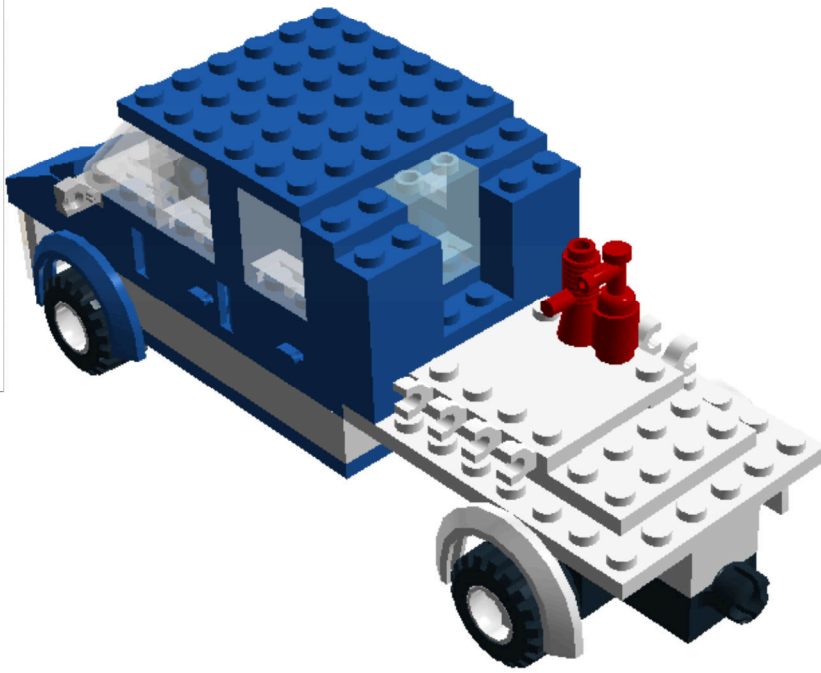
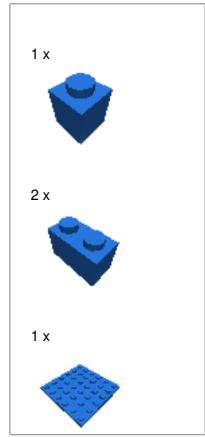

Step 37 of 91



Step 38 of 91

- 1 x 
- 1 x 
- 1 x 
- 1 x 

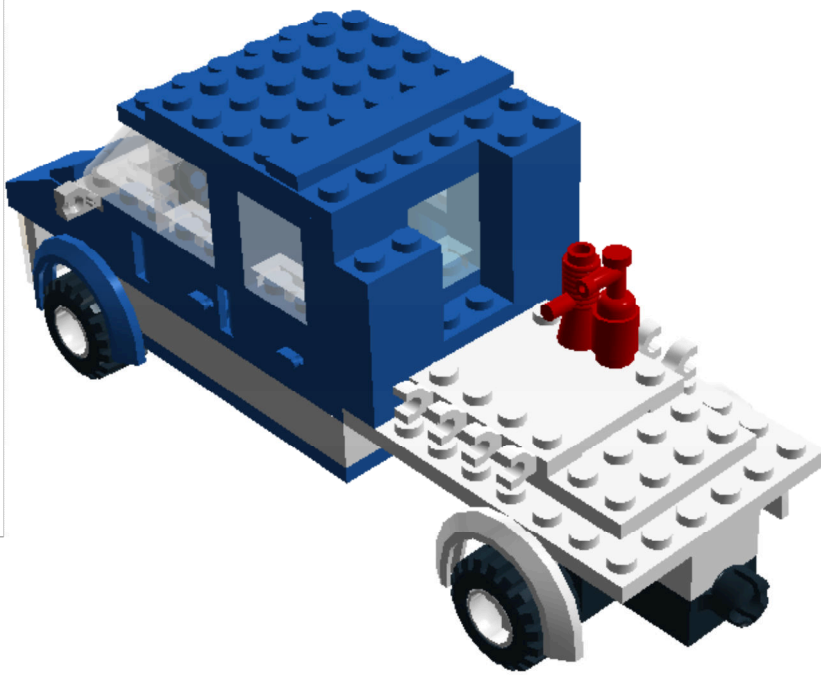

Step 39 of 91

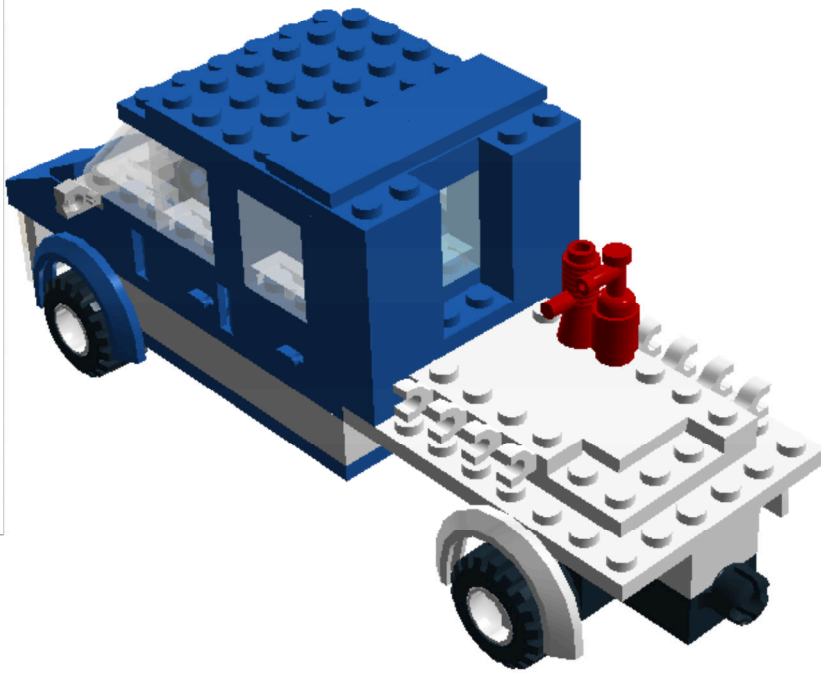
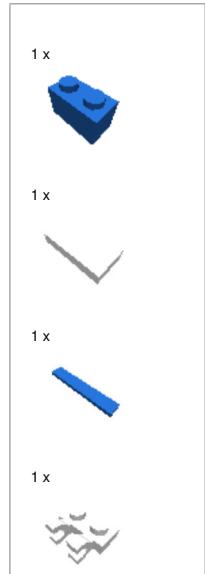

Step 40 of 91

2 x



1 x

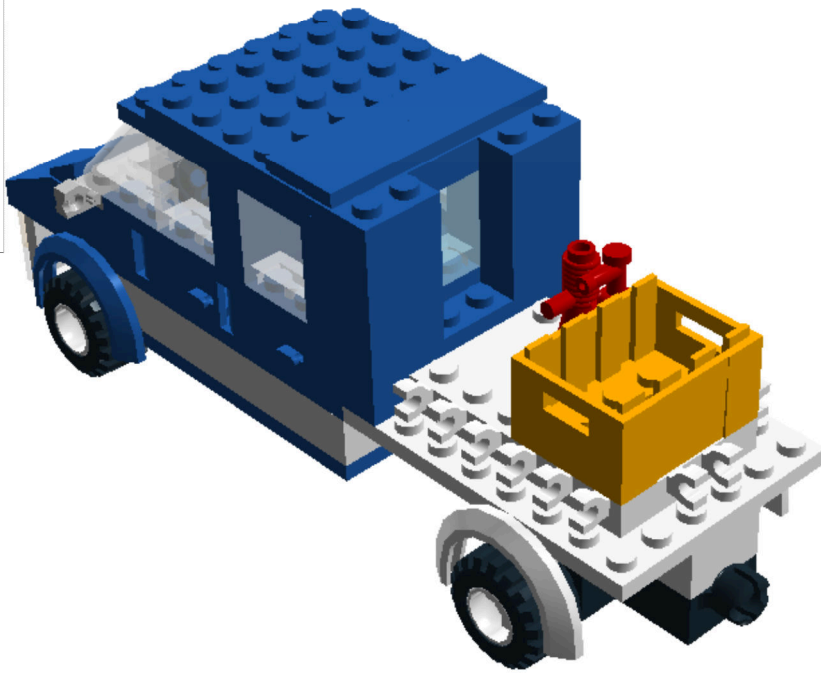

Step 41 of 91

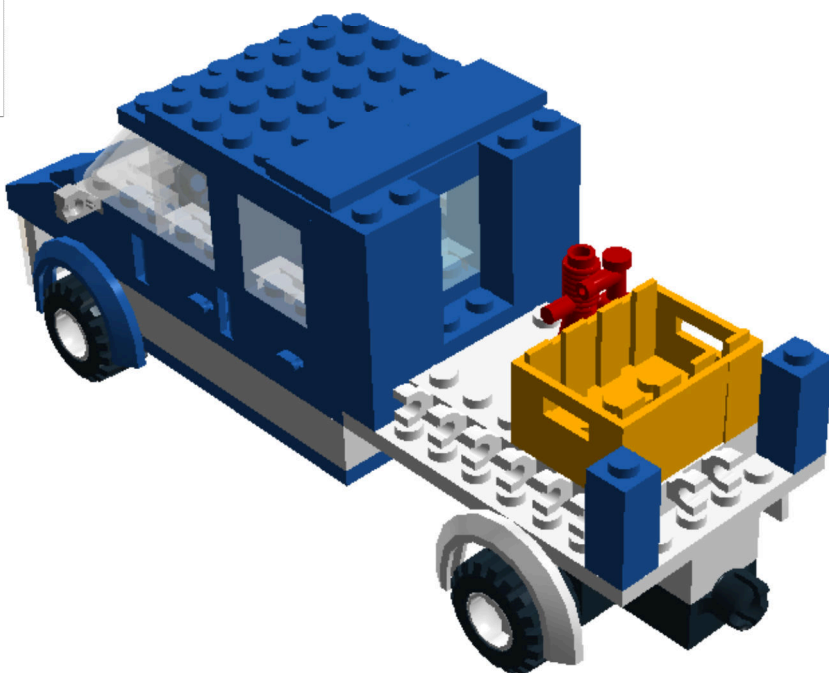



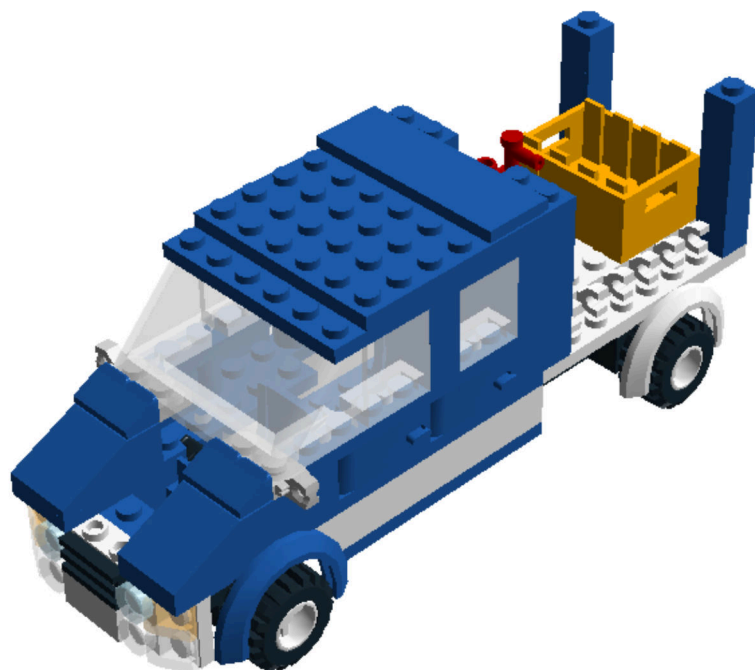

Step 42 of 91

4 x



Step 43 of 91

- 1 x 
- 1 x 
- 1 x 
- 1 x 

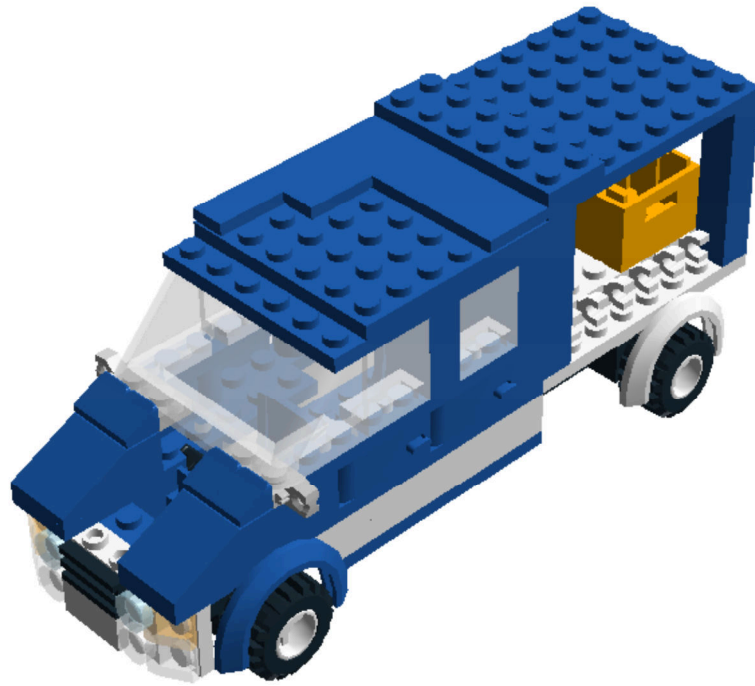

Step 44 of 91

1 x



2 x



1 x

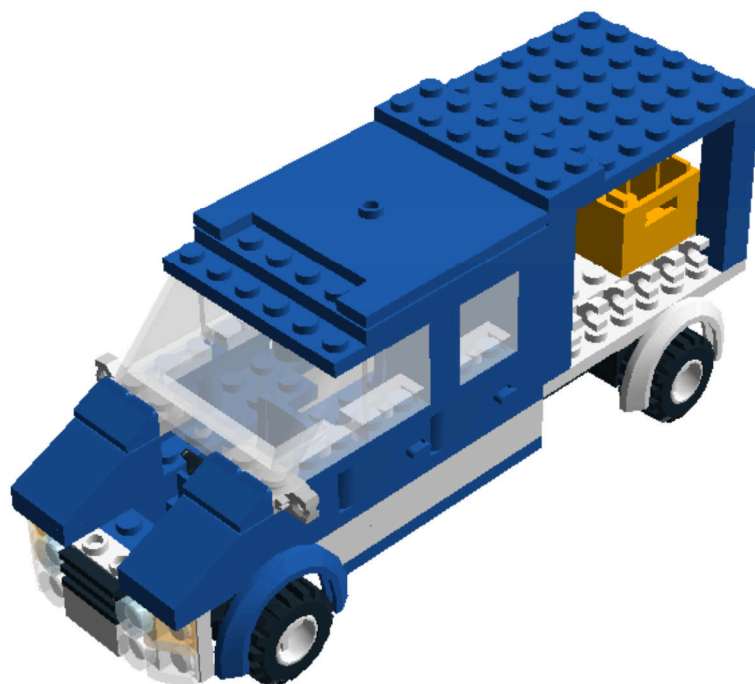

Step 45 of 91

3 x



1 x



Step 46 of 91





3 x

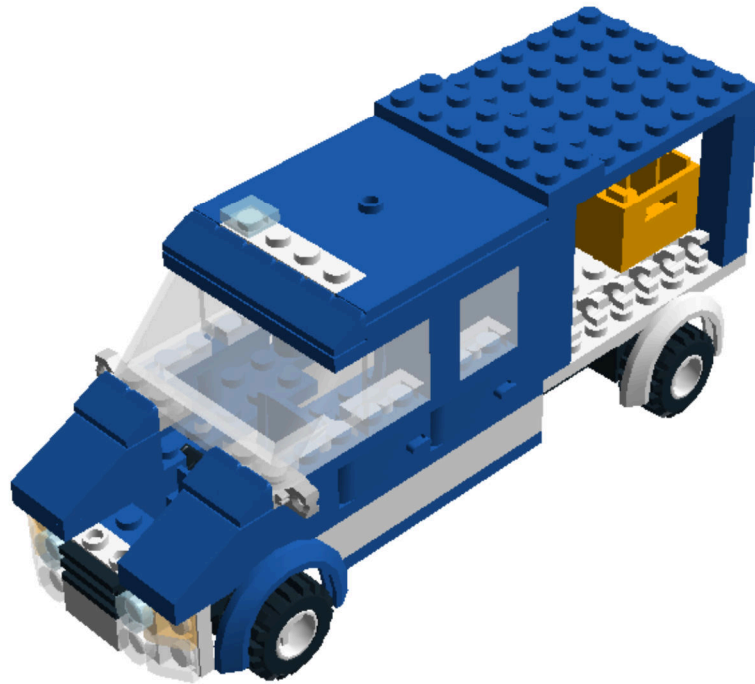

1 x



Step 47 of 91

- 1 x 
- 1 x 
- 1 x 
- 1 x 

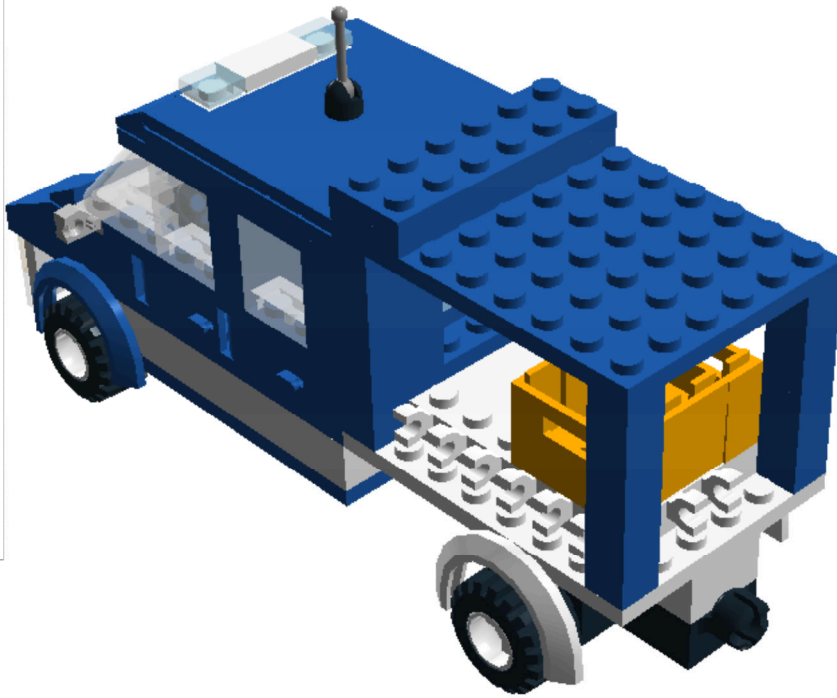

Step 48 of 91

3 x



1 x

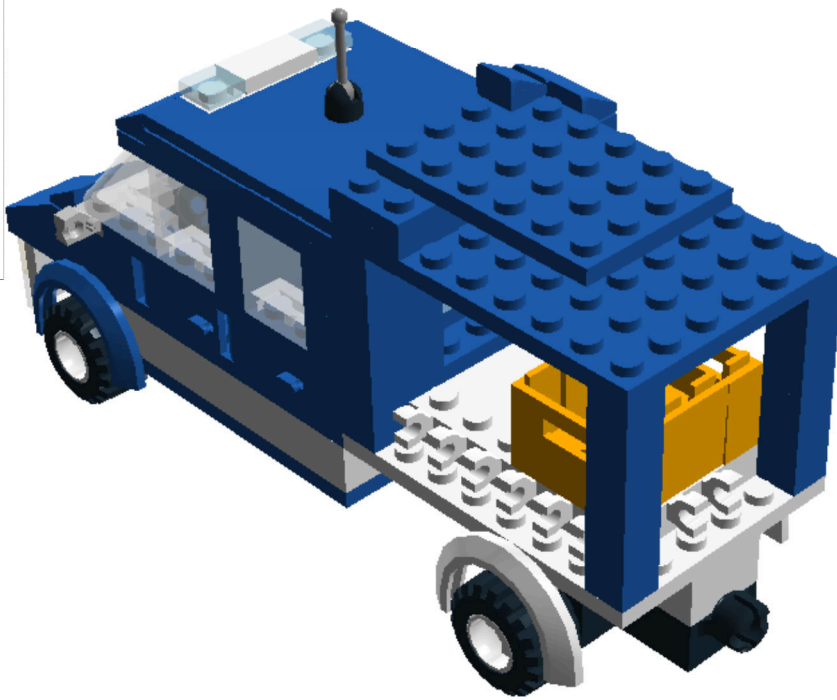

Step 49 of 91

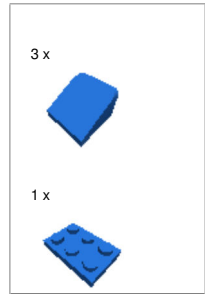

Step 50 of 91

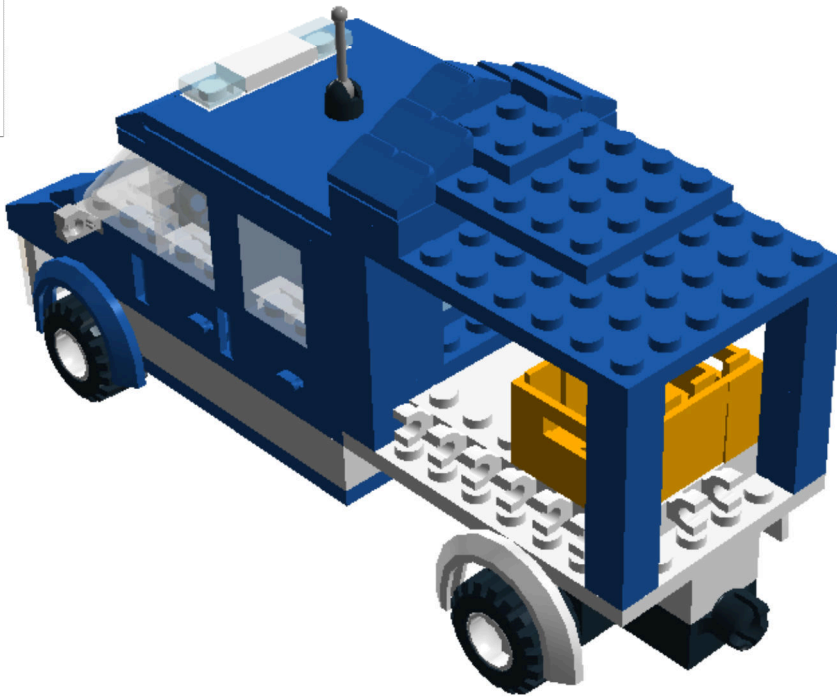
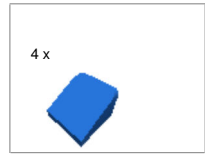





Step 51 of 91

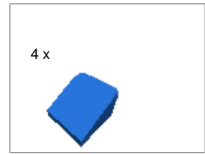

Step 52 of 91







Step 53 of 91

- 1 x 
- 1 x 
- 1 x 
- 1 x 



Step 54 of 91

- 1 x 
- 1 x 
- 1 x 
- 1 x 

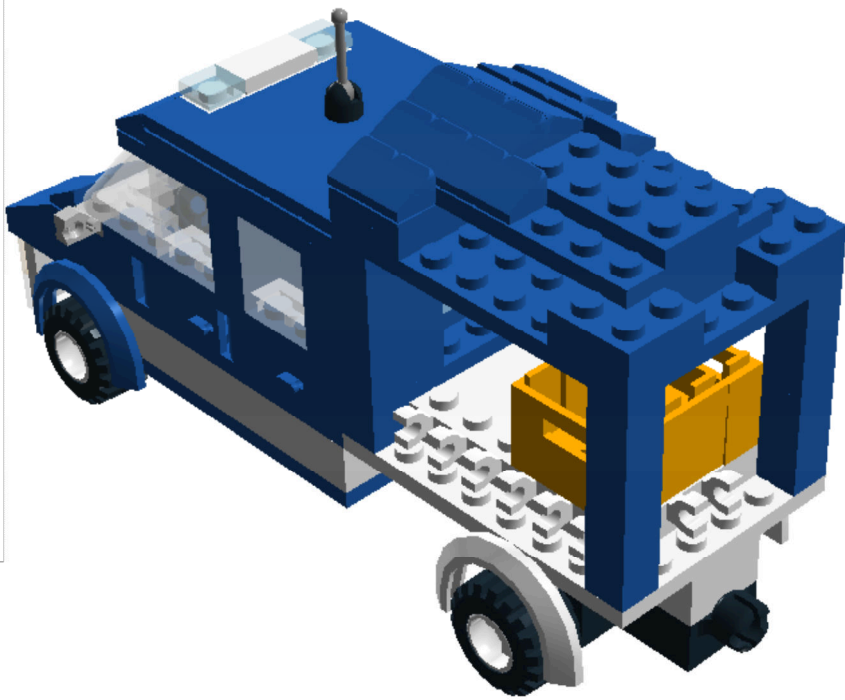

Step 55 of 91

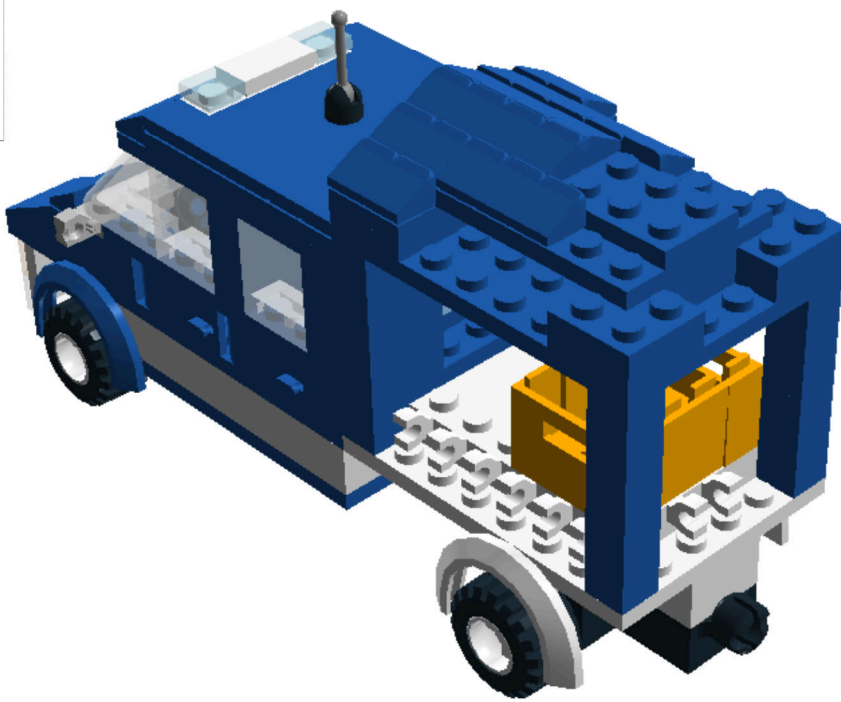

Step 56 of 91

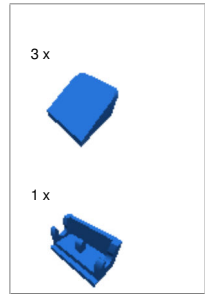

Step 57 of 91

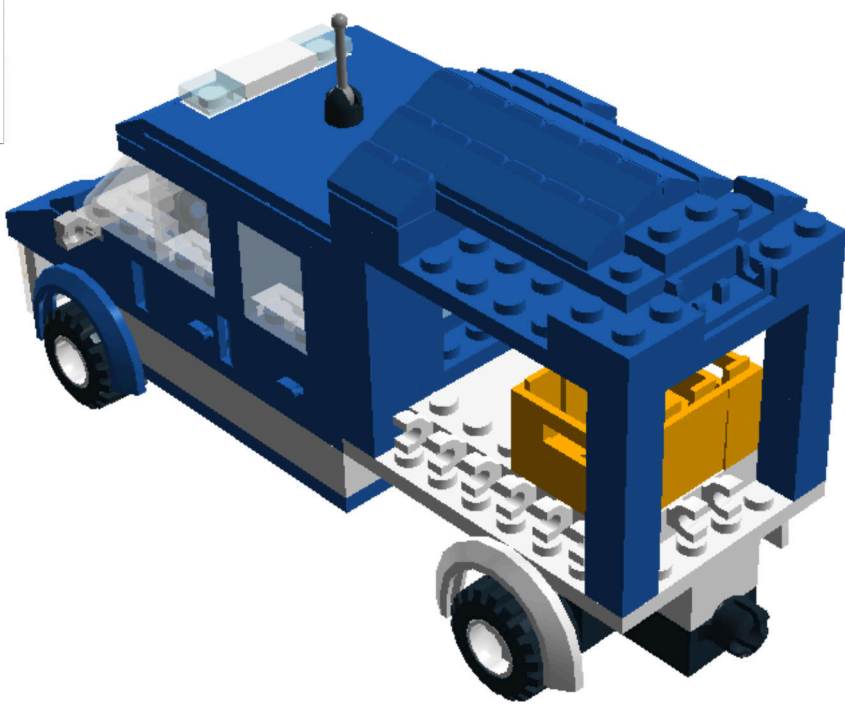

Step 58 of 91

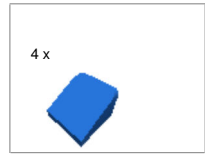

Step 59 of 91



Step 60 of 91



Step 61 of 91

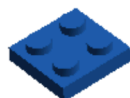

Step 62 of 91

1 x



2 x



1 x

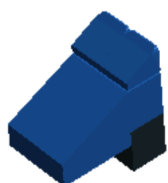

Step 63 of 91



Step 64 of 91

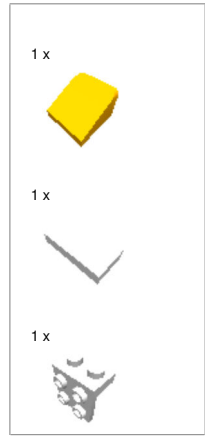

Step 65 of 91



Step 66 of 91

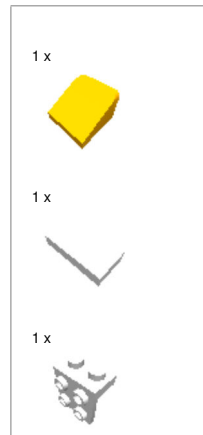

Step 67 of 91



Step 68 of 91

1 x



1 x



1 x



Step 69 of 91



Step 70 of 91

1 x



1 x



1 x



Step 71 of 91



Step 72 of 91

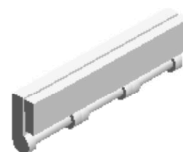
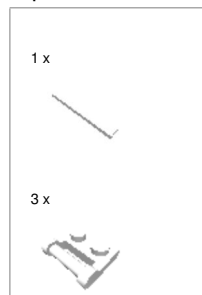

Step 73 of 91



Step 74 of 91

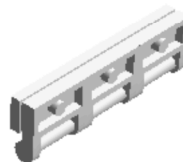
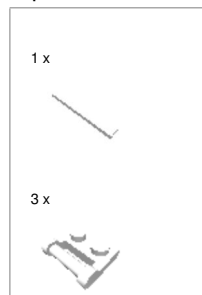

Step 75 of 91



Step 76 of 91

2 x



1 x



1 x

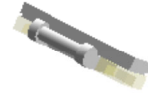

Step 77 of 91

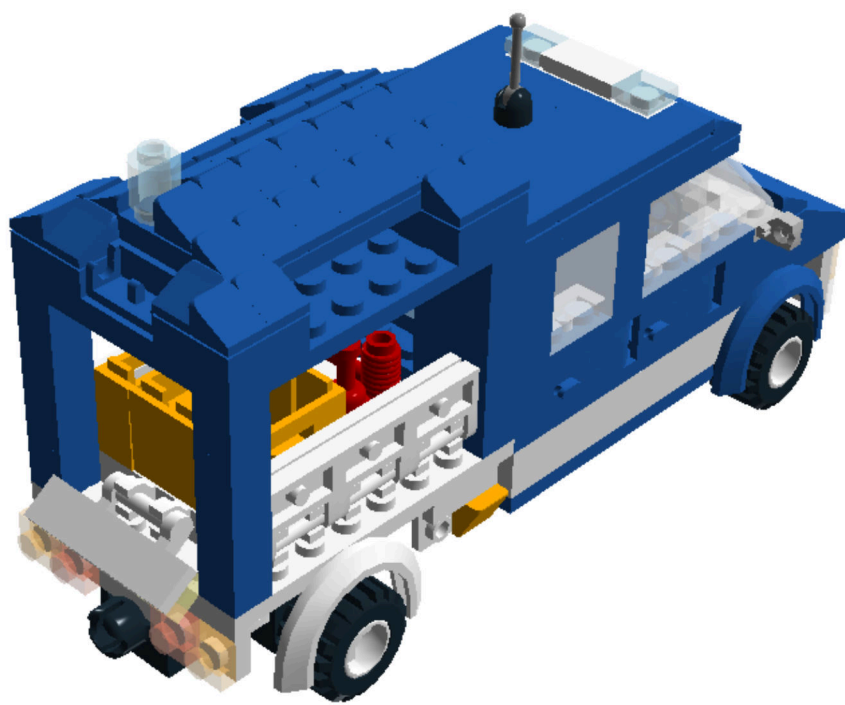

Step 78 of 91

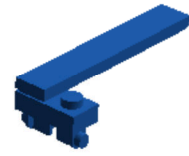
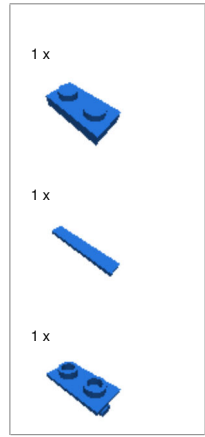

Step 79 of 91

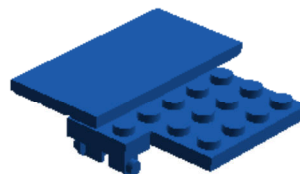
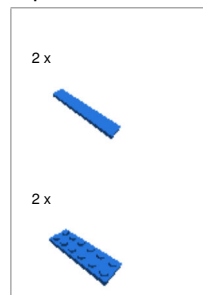

Step 80 of 91

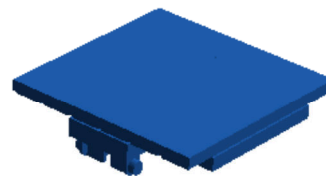
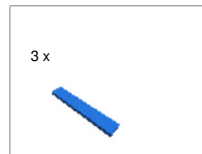

Step 81 of 91

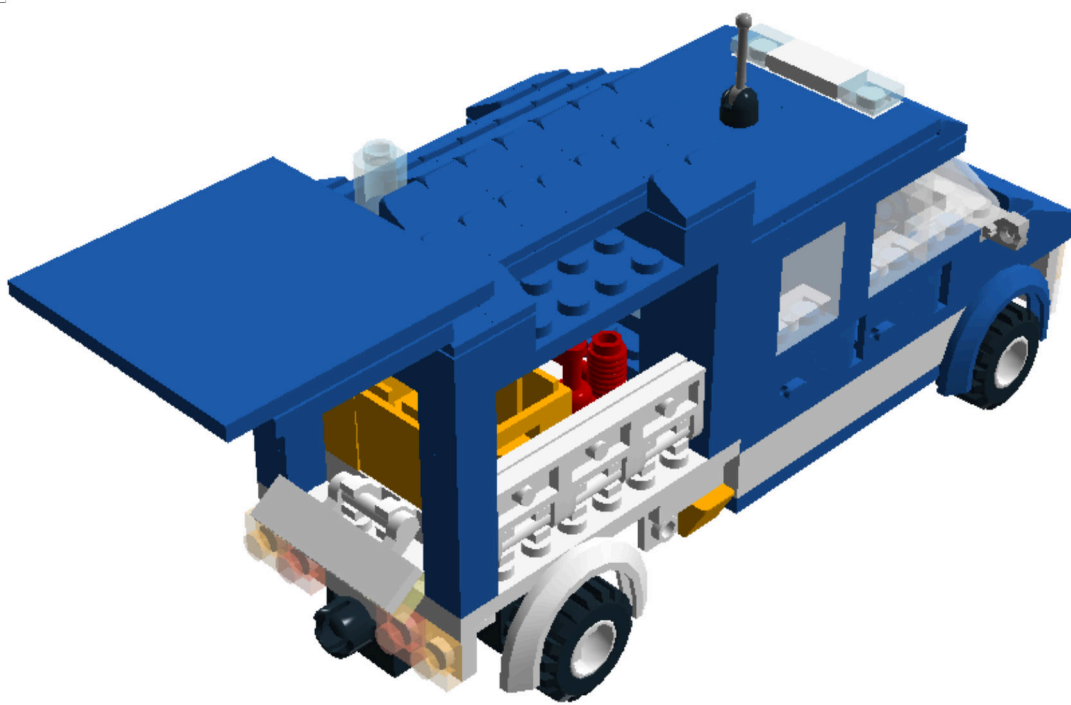

Step 82 of 91

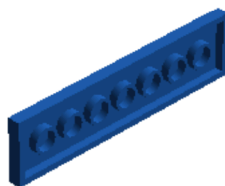
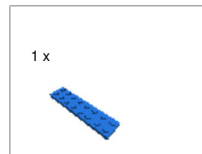

Step 83 of 91

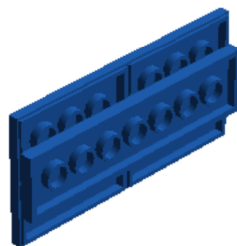
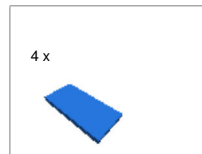

Step 84 of 91

1 x



2 x



1 x

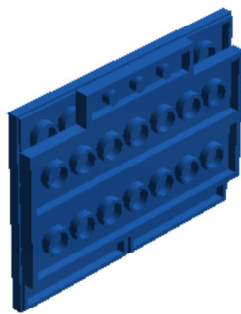

Step 85 of 91

2 x



2 x

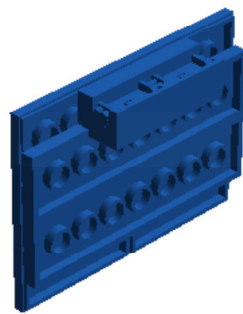

Step 86 of 91

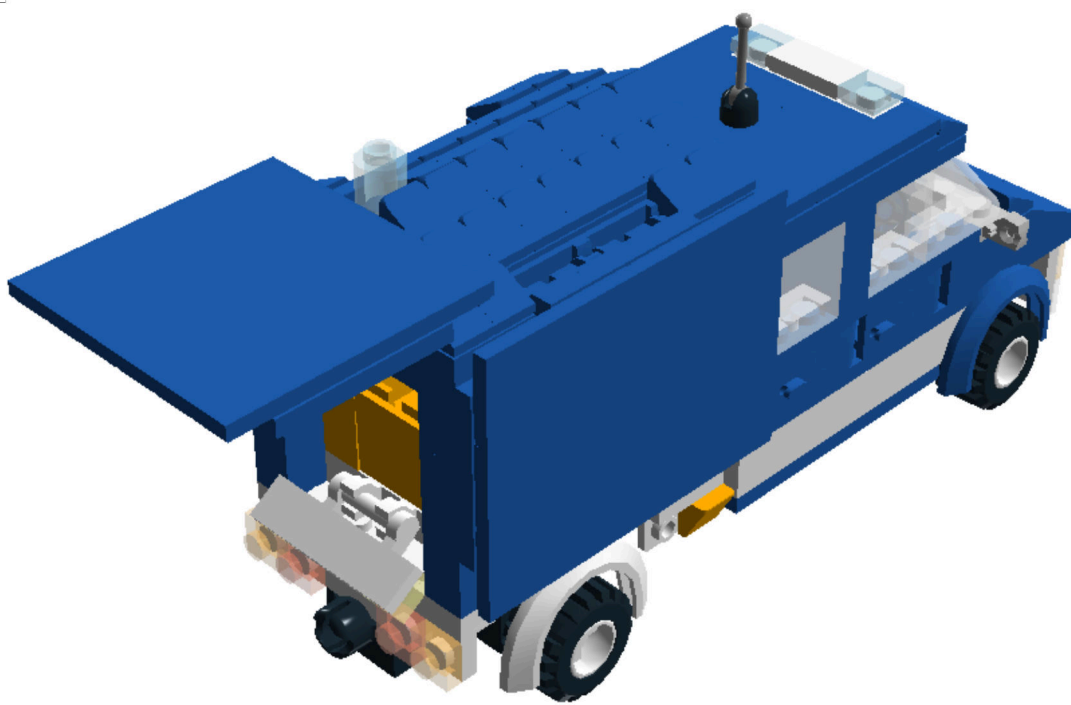

Step 87 of 91

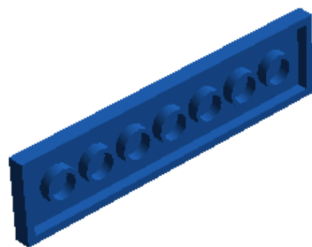
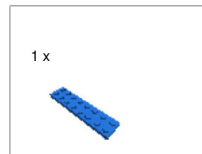

Step 88 of 91

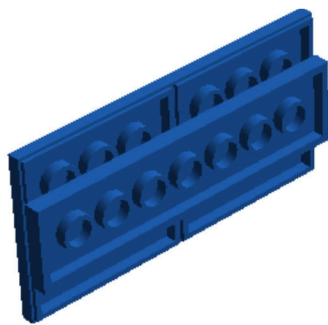
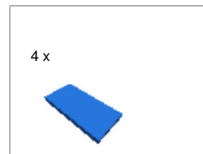

Step 89 of 91

1 x



1 x



1 x



1 x

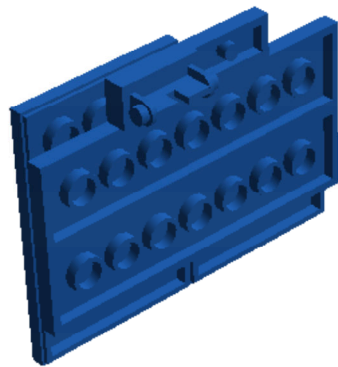

Step 90 of 91

1 x



1 x



2 x

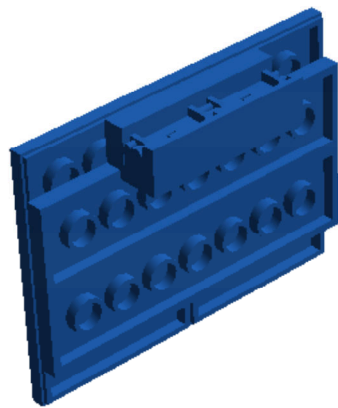

Step 91 of 91

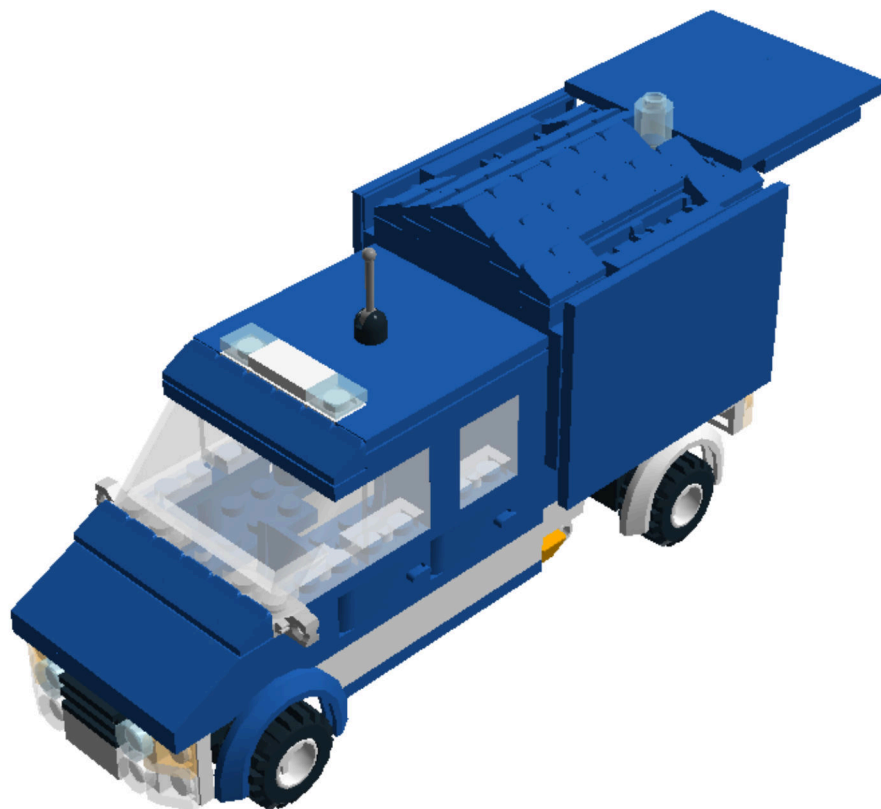

12 x  BRICK 1X1 - Klares Blau

2 x  BRICK 1X2 - Weiss

12 x  BRICK 1X2 - Klares Blau

1 x  BRICK 1X2 - Schwarz

2 x  BRICK 1X4 - Weiss

1 x  BRICK 1X4 WITHOUT PINS - Weiss

1 x  BRICK 2X6 - Klares Blau

1 x  BRICK 2X8 - Weiss

1 x  ROUND BRICK 1X1 - Klares Rot

1 x  ROUND BRICK 1X1 - Tr. Blau

1 x  BRICK 1X4 W. 4 KNOBS - Klares Blau

49 x  ROOF TILE 1X1X2/3, PC - Klares Blau

2 x  ROOF TILE 1X1X2/3, PC - Transparent

2 x  ROOF TILE 1X1X2/3, PC - Tr. Klares Orange

2 x  ROOF TILE 1X1X2/3, PC - Flammend Gelb Orange

2 x  ROOF TILE 2X2/45 INV. - Weiss

3 x  ROOF TILE 2X3/25° - Klares Blau

2 x  FLAT TILE 1X1 - Tr. Blau

2 x  PLATE 1X1 - Tr. Rot

2 x  PLATE 1X1 - Tr. Gelb

2 x  PLATE 1X1 - Tr. Klares Orange

1 x  RADIATOR GRILLE 1X2 - Schwarz

6 x  FLAT TILE 1X2 - Weiss

2 x  FLAT TILE 1X2 - Klares Blau

3 x  PLATE 1X2 - Klares Blau

4 x  PLATE 1X2 - Schwarz

2 x  FLAT TILE 1X3 - Weiss

1 x  FLAT TILE 1X4 - Weiss

3 x  FLAT TILE 1X4 - Klares Blau

2 x  PLATE 1X3 - Klares Blau

4 x  CORNER PLATE 1X2X2 - Klares Blau

3 x  PLATE 2X2 - Klares Blau

1 x  PLATE 2X2 - Schwarz

2 x  PLATE 1X4 - Weiss

4 x  PLATE 1X4 - Klares Blau

2 x  FLAT TILE 1X6 - Weiss

8 x  FLAT TILE 1X6 - Klares Blau

































1 x  PLATE 2X2 W 1 KNOB - Klares Blau

12 x  FLAT TILE 2X4 - Klares Blau

1 x  PLATE 2X3 - Klares Blau

1 x  PLATE 2X3 - Schwarz

5 x  PLATE 1X6 - Klares Blau

- | | | |
|---|--|---|
| 1 x  PLATE 2X4 - Klares Blau | 5 x  PLATE 2X6 - Klares Blau | 3 x  PLATE 2X6 - Schwarz |
| 1 x  PLATE 4X4 - Schwarz | 6 x  PLATE 2X8 - Klares Blau | 1 x  PLATE 4X6 - Weiss |
| 2 x  PLATE 4X6 - Klares Blau | 1 x  PLATE 2X16 - Schwarz | 2 x  PLATE 6X6 - Klares Blau |
| 1 x  PLATE 6X8 - Weiss | 1 x  PLATE 6X8 - Klares Blau | 2 x  FLAT TILE 1X1, ROUND - Transparent |
| 2 x  FLAT TILE 1X1, ROUND - Tr. Blau | 2 x  PLATE 1X2 W/STUB VERTICAL/END - Helles Steingrau | 7 x  PLATE 1X2 W. STICK 3.18 - Weiss |
| 7 x  PLATE 1X2 W/HOLDER, VERTICAL - Weiss | 2 x  ANGULAR PLATE 1,5 TOP 1X2 1/2 - Weiss | 1 x  PLATE 2X2 W. BALL SOCKET - Schwarz |
| 2 x  ANGLE PLATE 1X2 / 2X2 - Weiss | 1 x  PLATE 2X6X2/3 W 4 HOR. KNOB - Weiss | 1 x  WINDSCREEN 6X3X2 - Transparent |
| 4 x  WALLELEMENT 1X2X2 - Transparent | 1 x  WALLELEMENT 1X2X2 - Tr. Blau | 2 x  RIGHT DOOR 1X3 - Klares Blau |
| 2 x  LEFT DOOR 1X3 - Klares Blau | 4 x  RIM WIDE W. HOLE Ø11 - Weiss | 4 x  BEARING ELEMENT 2X2, SINGLE - Schwarz |
| 4 x  TYRE NORMAL WIDE Ø21 X 12 - Schwarz | 1 x  MINI ANTENNA - Schwarz, Mittel Steingrau | 1 x  TAP Ø4.9/6.4 - Klares Rot |
| 2 x  SEAT 2X2X2 - Klares Blau | 1 x  BOX 3X4 - Flammend Gelb Orange | 1 x  CONSOLE W. WHEEL - Klares Blau, Schwarz |
| 2 x  BRICK 2X4X1 W. SCREEN - Weiss | 2 x  BRICK 2X4X1 W. SCREEN - Klares Blau | 5 x  PLATE 1X2 (ROCKING) - Klares Blau |
| 5 x  ROCKER BEARING 1X2 - Klares Blau | 1 x  MEGAPHONE - Klares Rot | |