

LEGO DIGITAL DESIGNER 4.2



Model Name:
Lego THW Lok Idd
blaulichhelden-de-
klappbar
Number of Bricks: 387



Step 1 of 142



Step 2 of 142

- 1 x 
- 1 x 
- 2 x 



Step 3 of 142

1 x



1 x



1 x



1 x

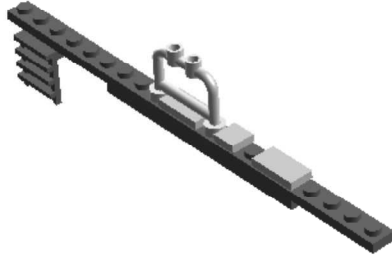

Step 4 of 142

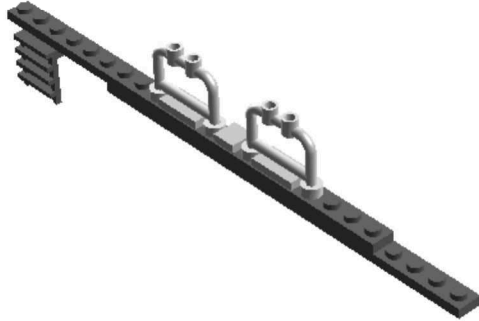
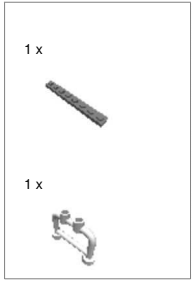

Step 5 of 142

1 x



1 x



1 x



1 x

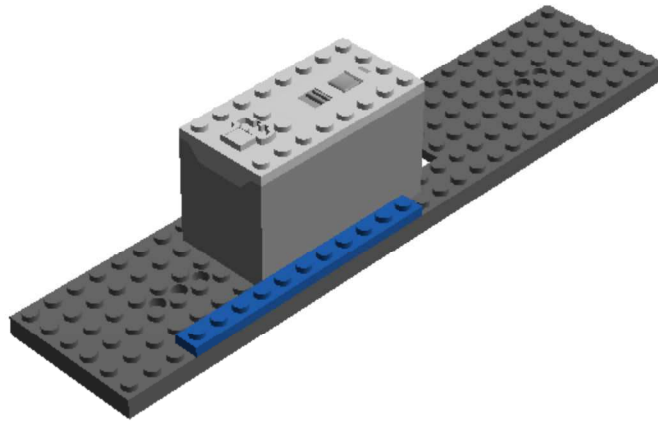

Step 6 of 142

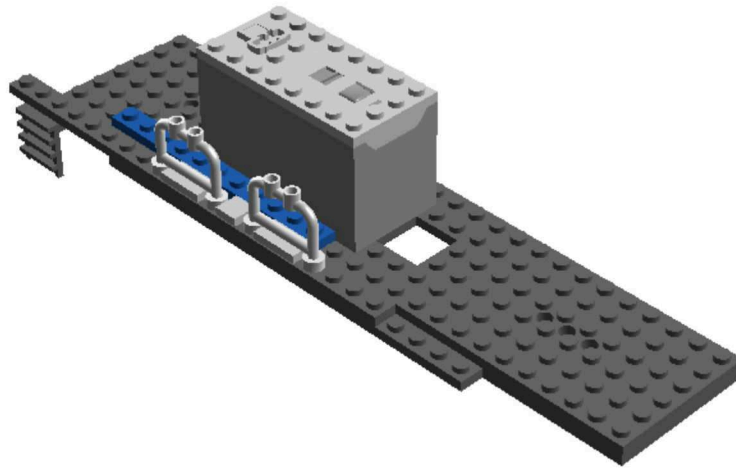

Step 7 of 142

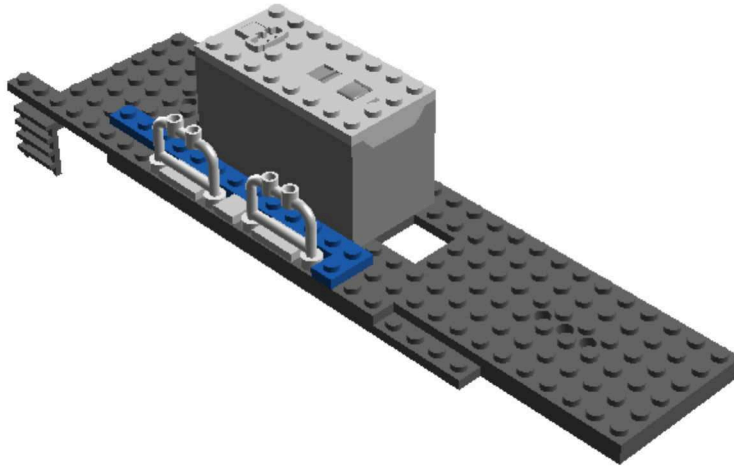

Step 8 of 142

1 x



1 x



1 x



1 x

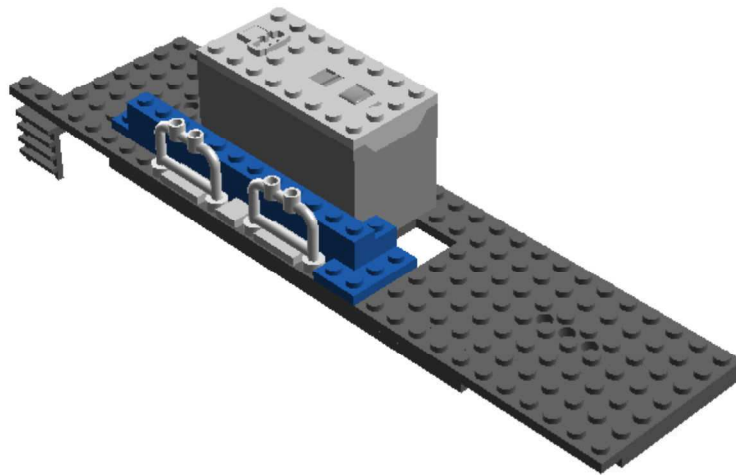

Step 9 of 142

1 x



1 x



2 x

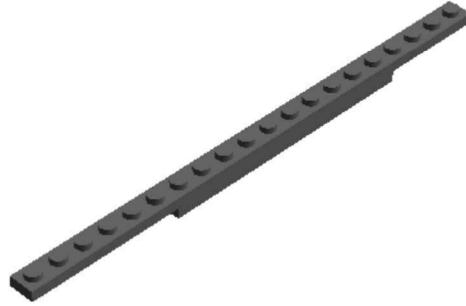

Step 10 of 142

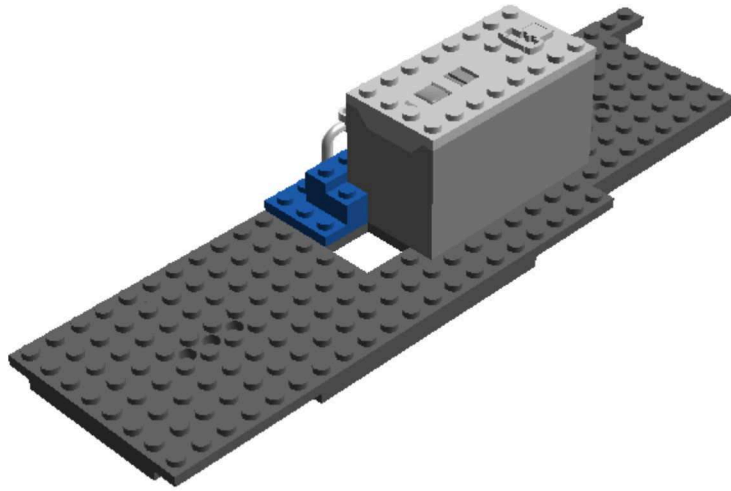

Step 11 of 142

1 x



1 x



1 x

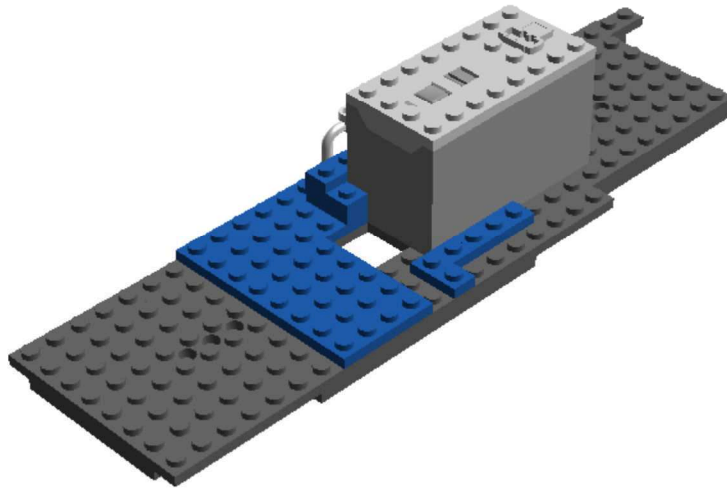

Step 12 of 142

1 x



1 x



1 x



1 x

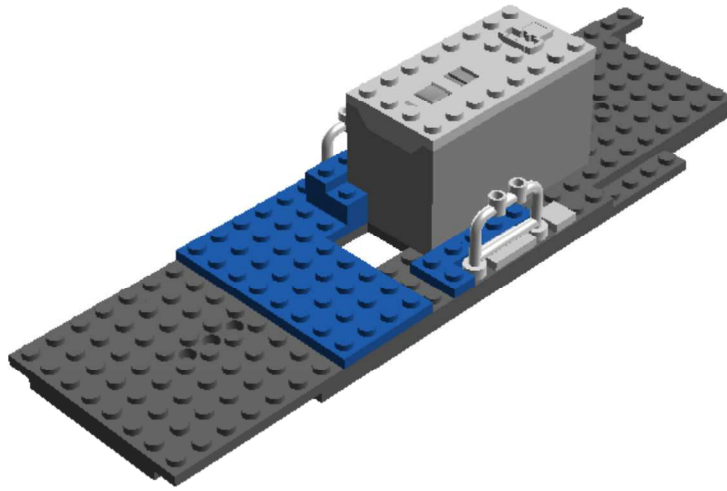

Step 13 of 142

1 x



1 x



1 x



1 x

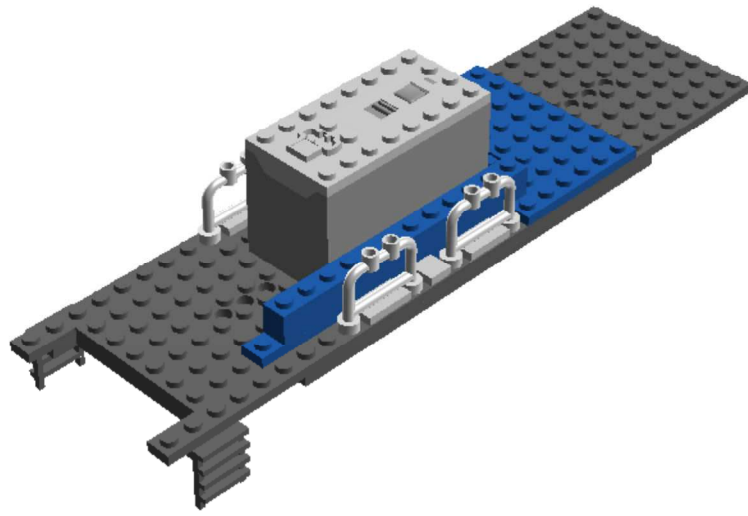

Step 14 of 142

1 x



1 x



1 x



1 x

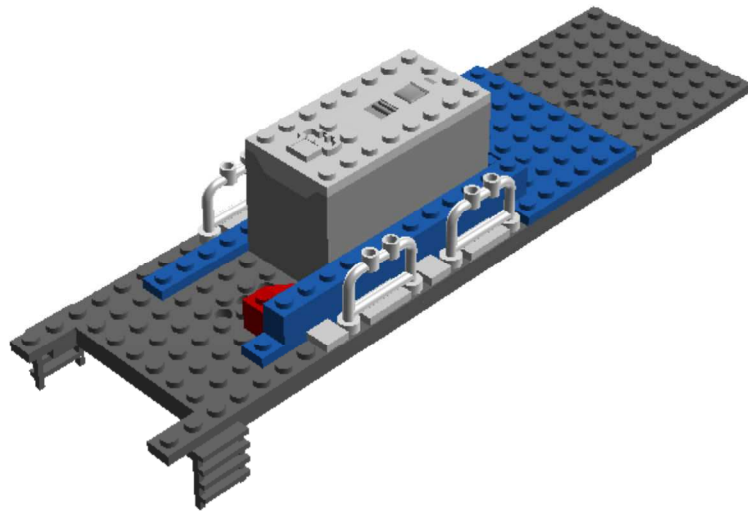

Step 15 of 142

1 x



1 x



1 x

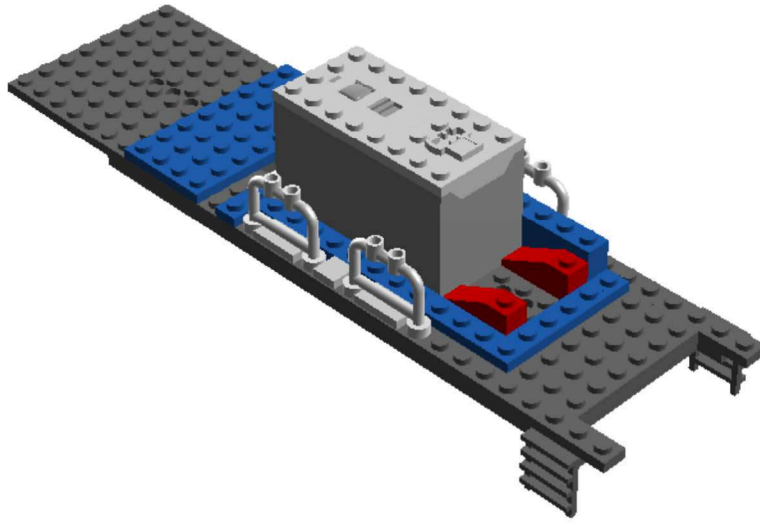

Step 16 of 142

1 x



1 x



1 x



1 x

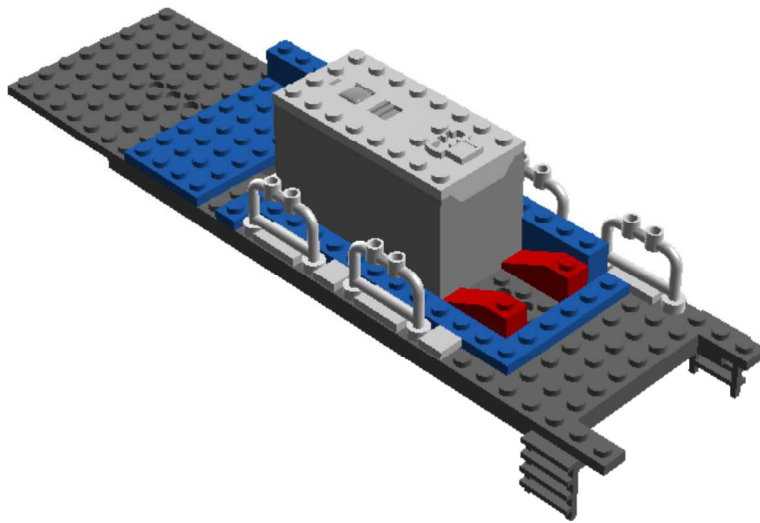

Step 17 of 142

1 x



1 x



1 x



1 x

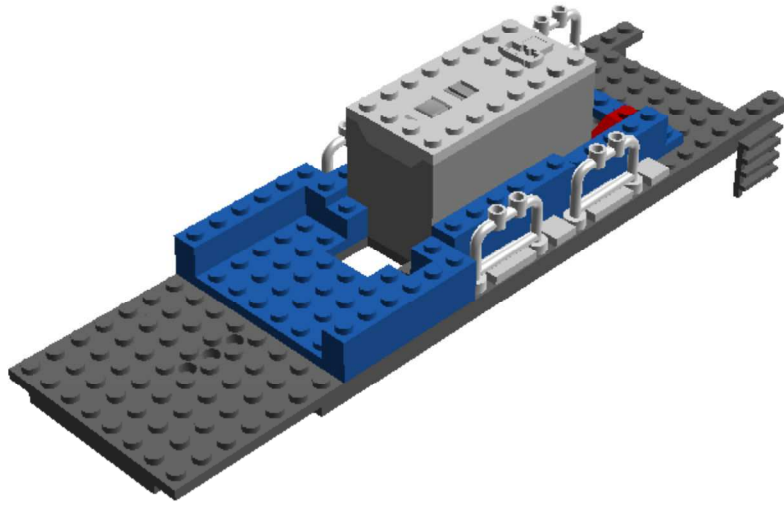

Step 18 of 142

1 x



1 x



1 x

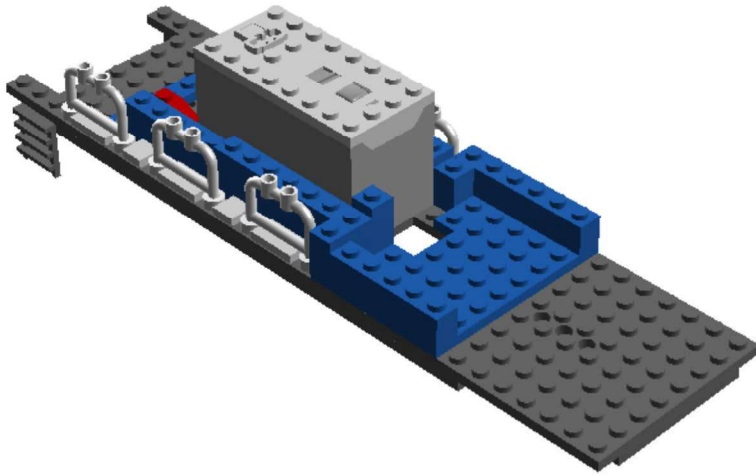

Step 19 of 142

1 x



1 x



1 x



1 x

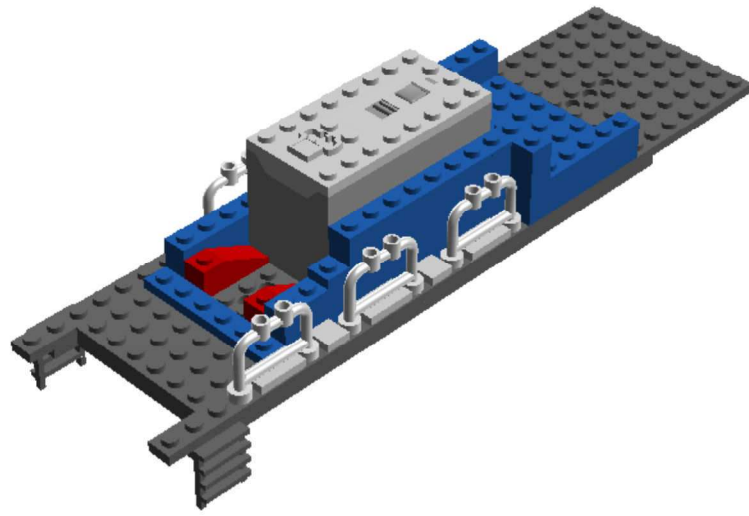

Step 20 of 142

1 x



1 x



1 x

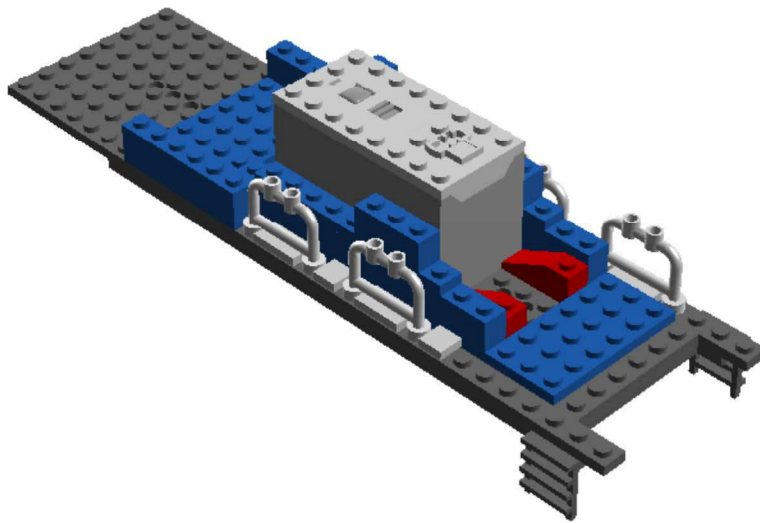

Step 21 of 142

1 x



1 x



1 x



1 x

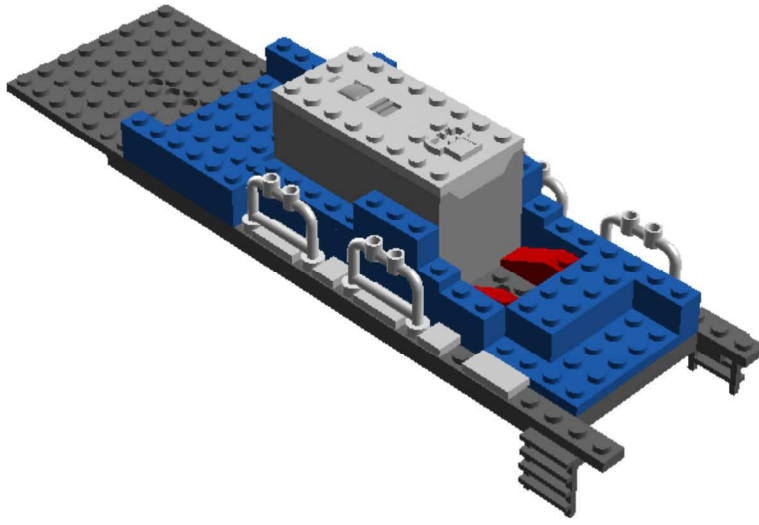

Step 22 of 142

1 x



1 x



1 x



1 x

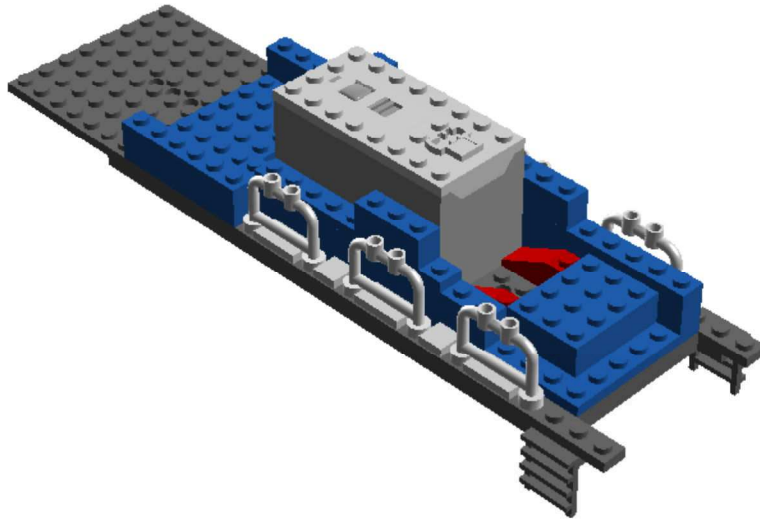

Step 23 of 142

1 x



1 x







1 x

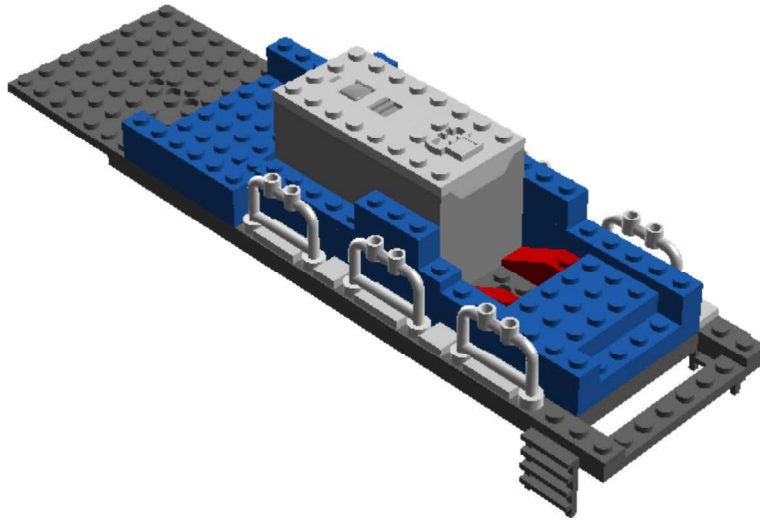

1 x



Step 24 of 142

- 1 x 
- 1 x 
- 1 x 
- 1 x 

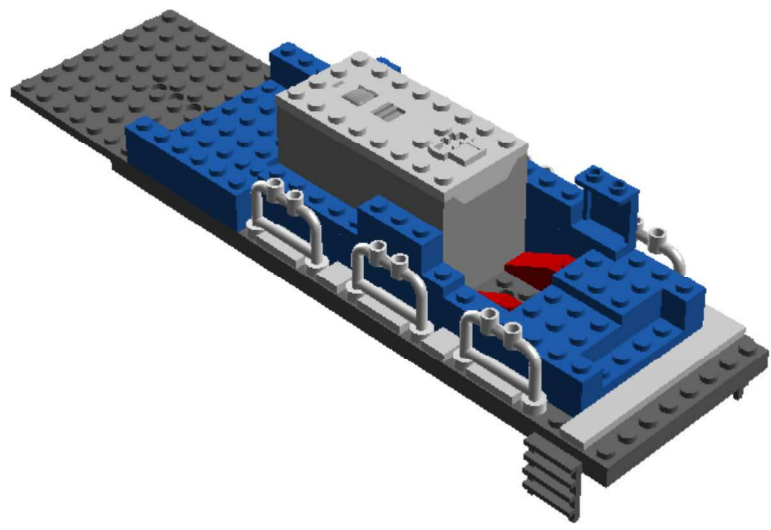

Step 25 of 142

1 x



1 x



1 x



1 x

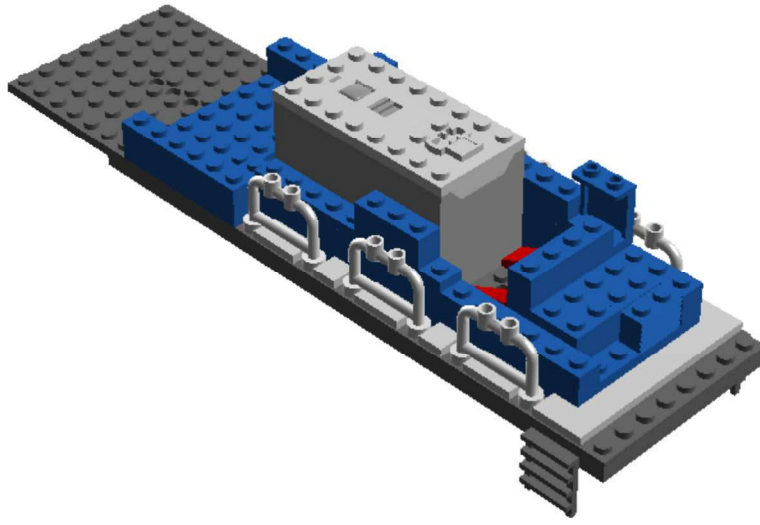

Step 26 of 142

2 x



1 x



1 x

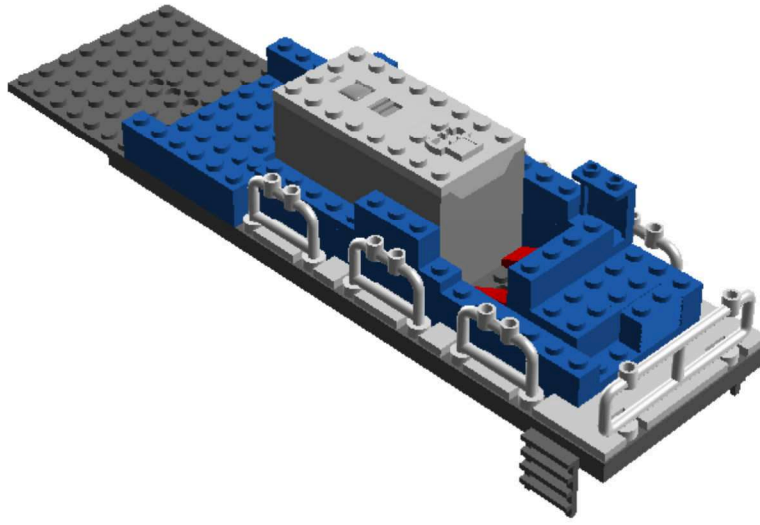

Step 27 of 142

1 x



1 x



1 x



1 x

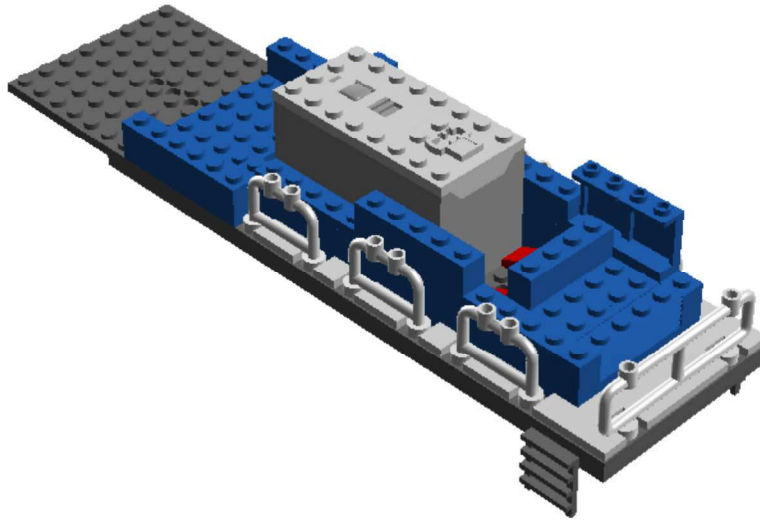

Step 28 of 142

1 x



1 x



1 x



1 x

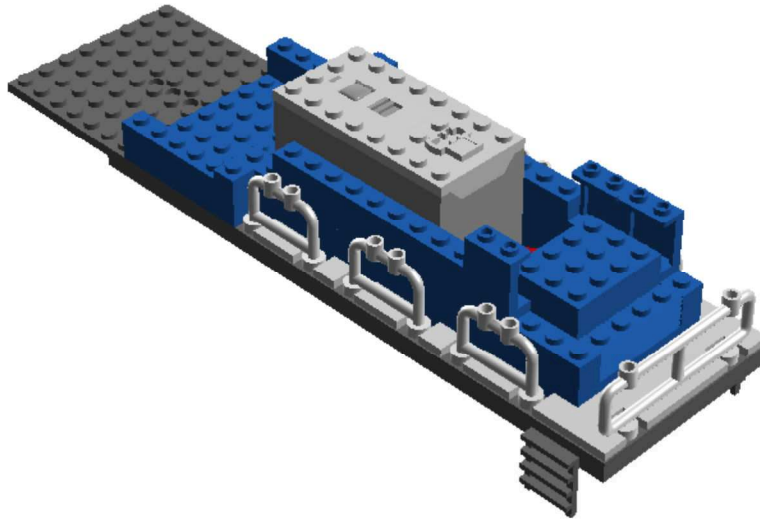

Step 29 of 142

1 x



1 x



1 x



1 x

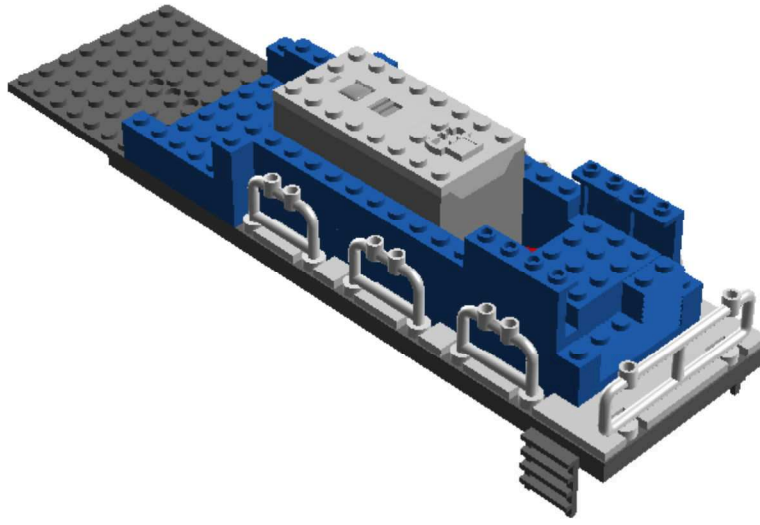

Step 30 of 142

1 x



1 x



1 x

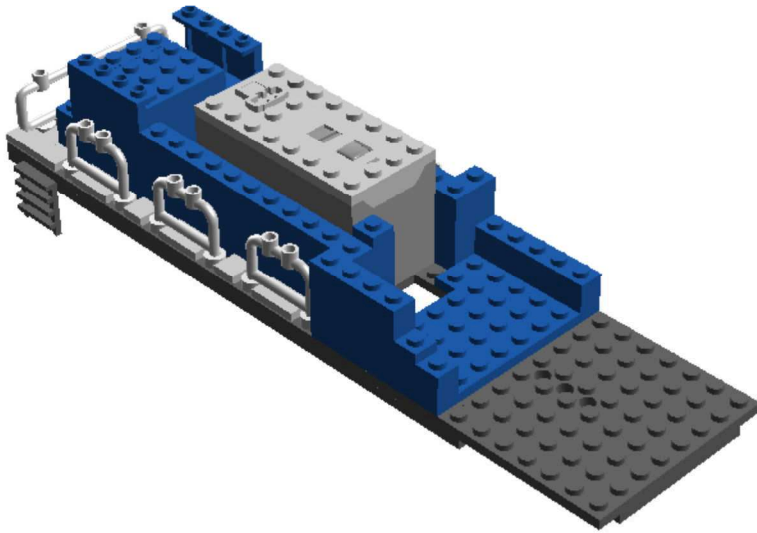

Step 31 of 142

1 x



1 x



1 x



1 x

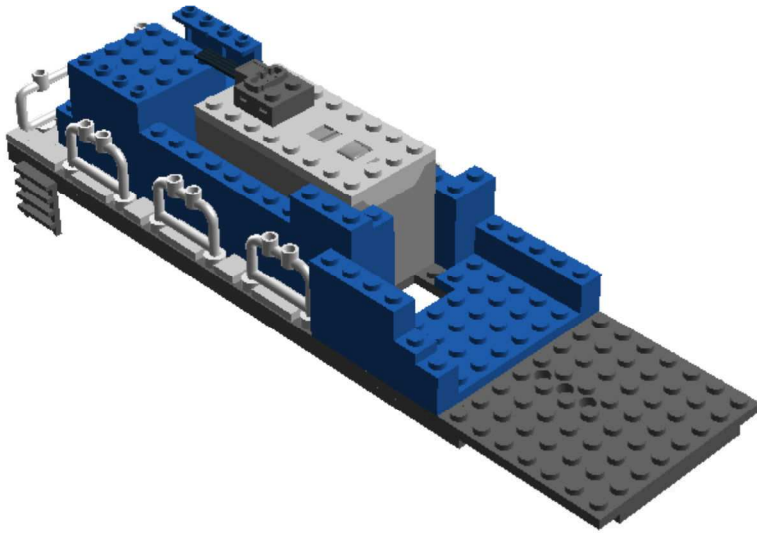

Step 32 of 142

1 x



2 x



1 x

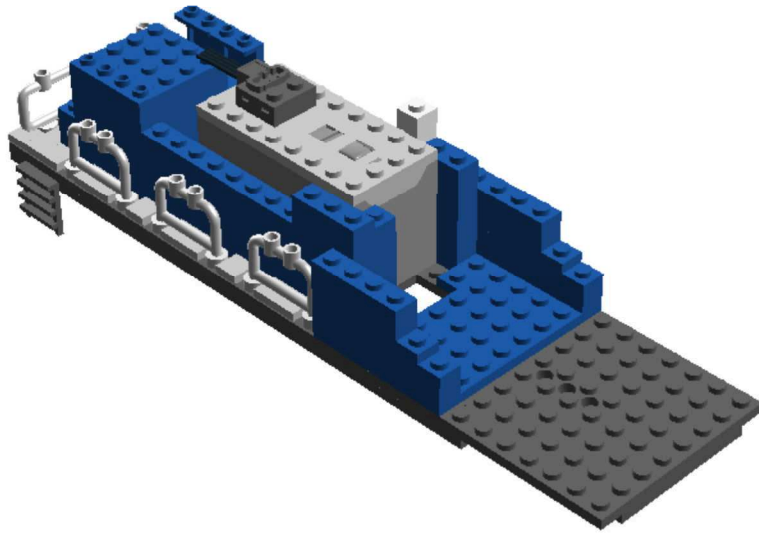

Step 33 of 142

1 x



1 x



1 x



1 x

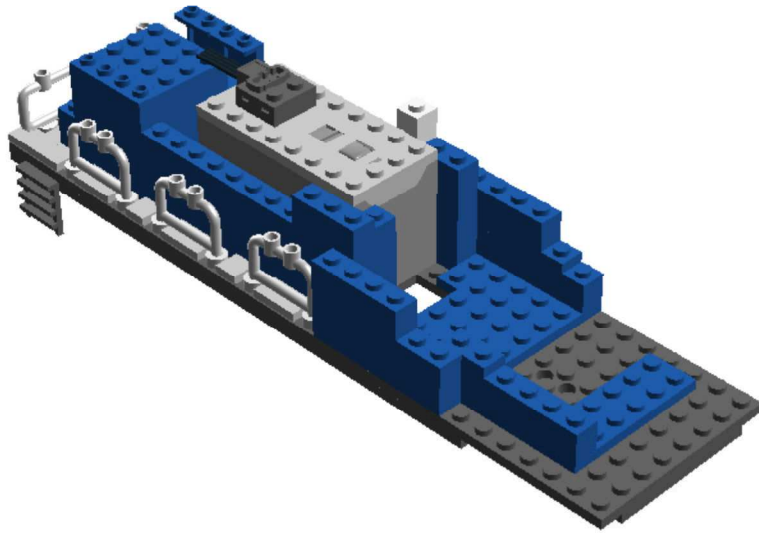

Step 34 of 142

1 x



1 x



1 x



1 x

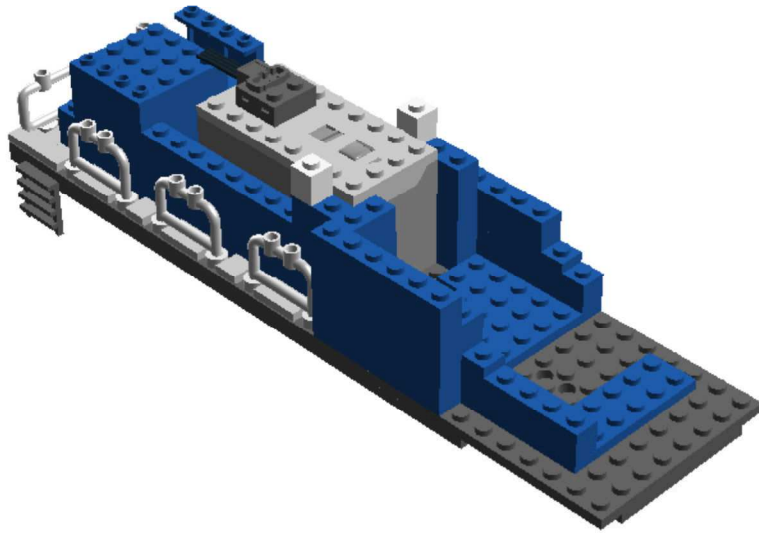

Step 35 of 142

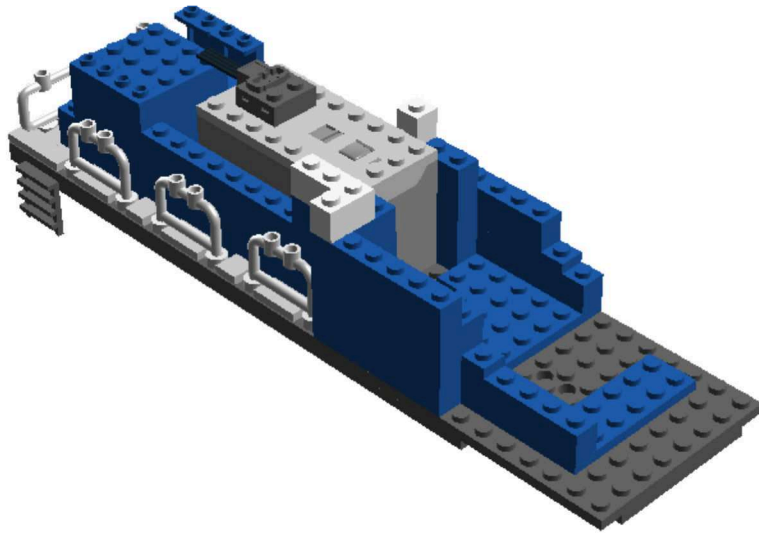

Step 36 of 142

1 x



2 x



Step 37 of 142

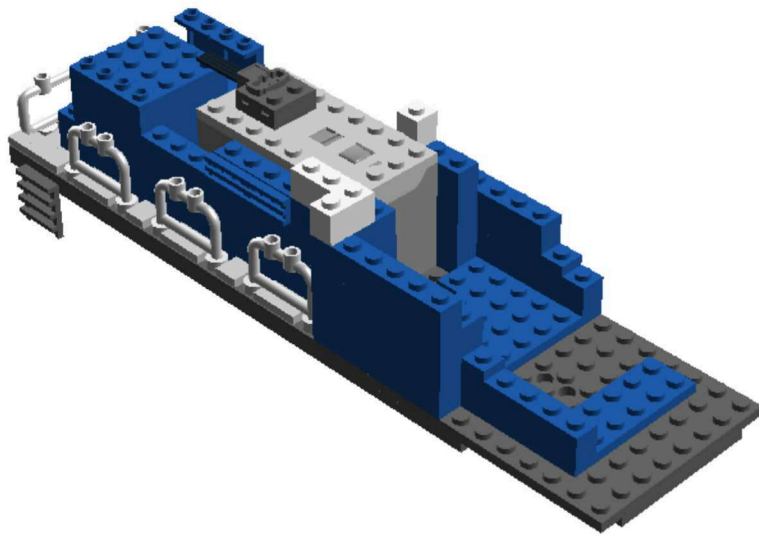

Step 38 of 142

1 x



2 x



Step 39 of 142

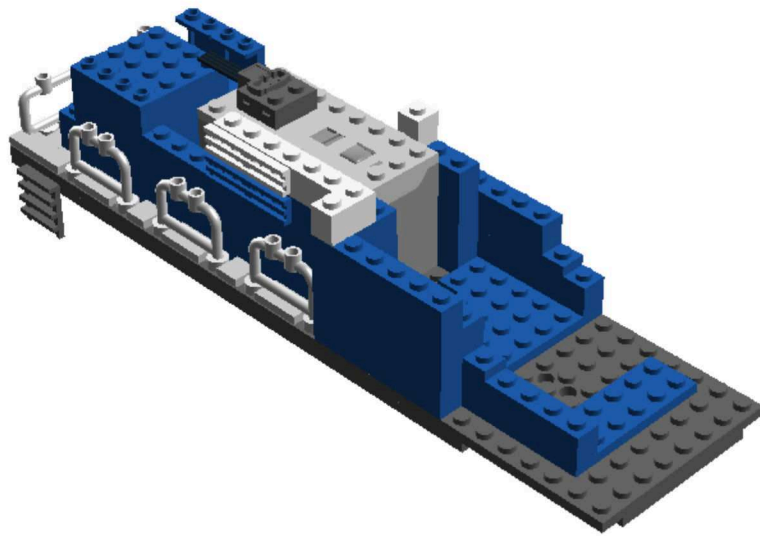

Step 40 of 142

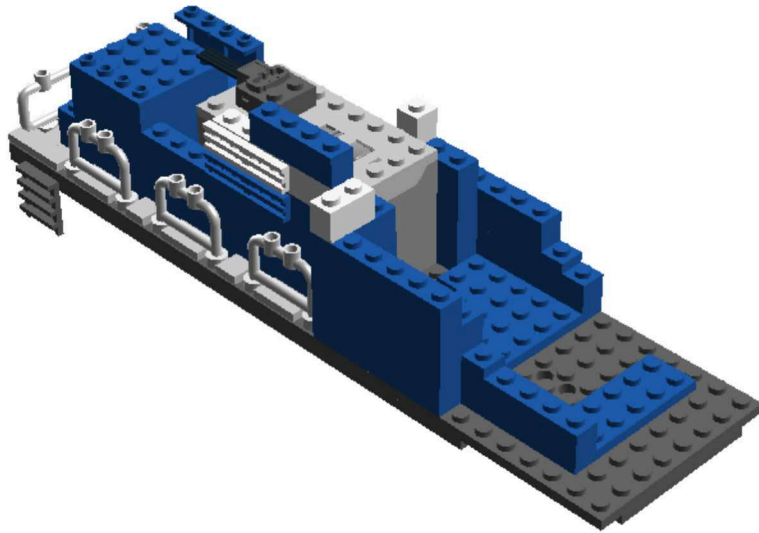
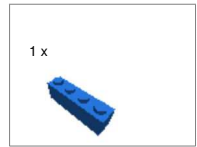

Step 41 of 142

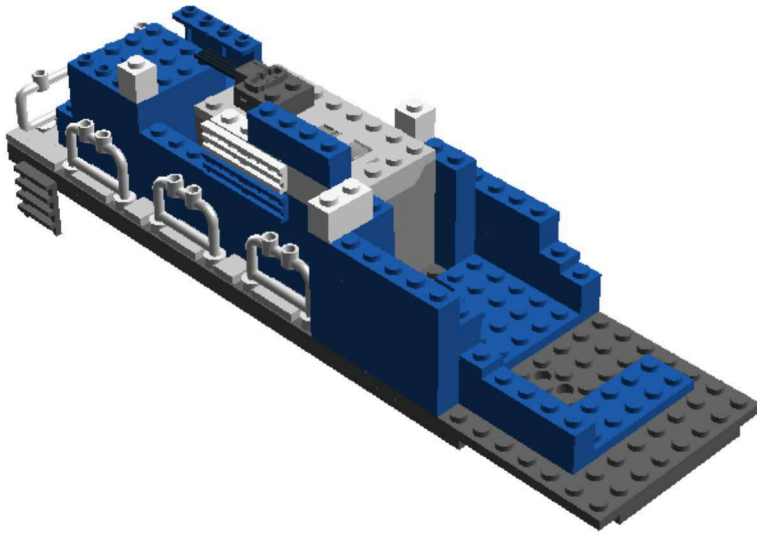

Step 42 of 142

1 x



2 x



Step 43 of 142

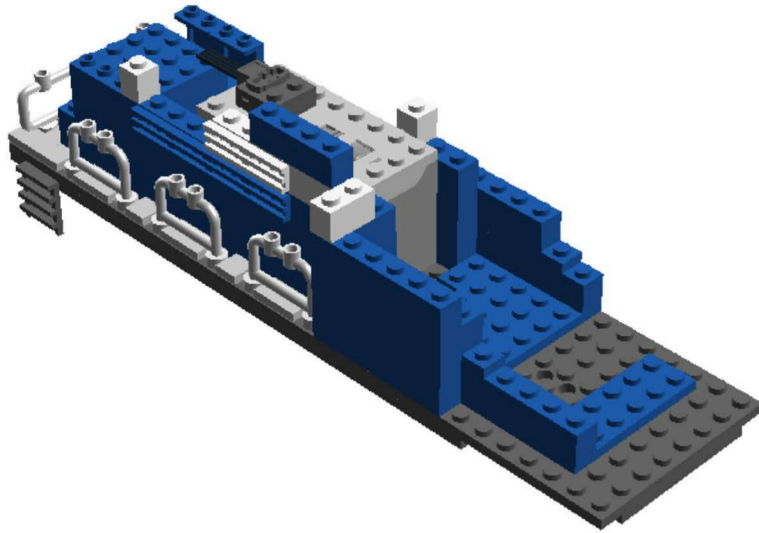

Step 44 of 142

1 x



2 x



Step 45 of 142

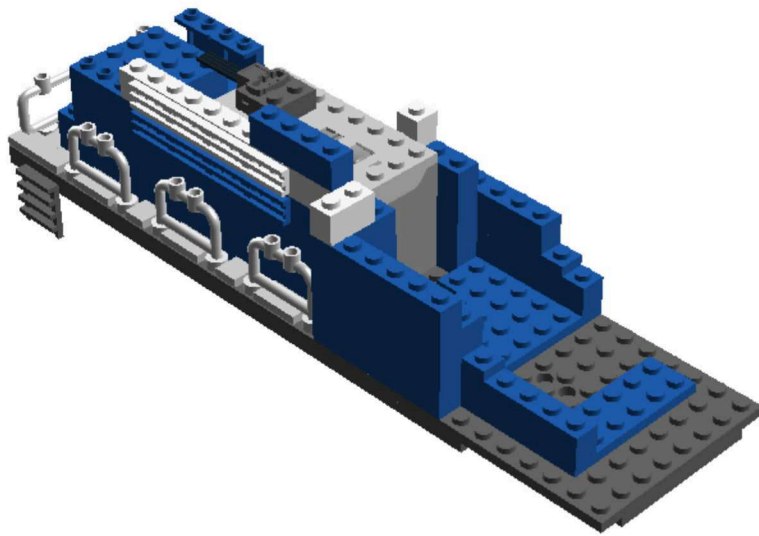

Step 46 of 142

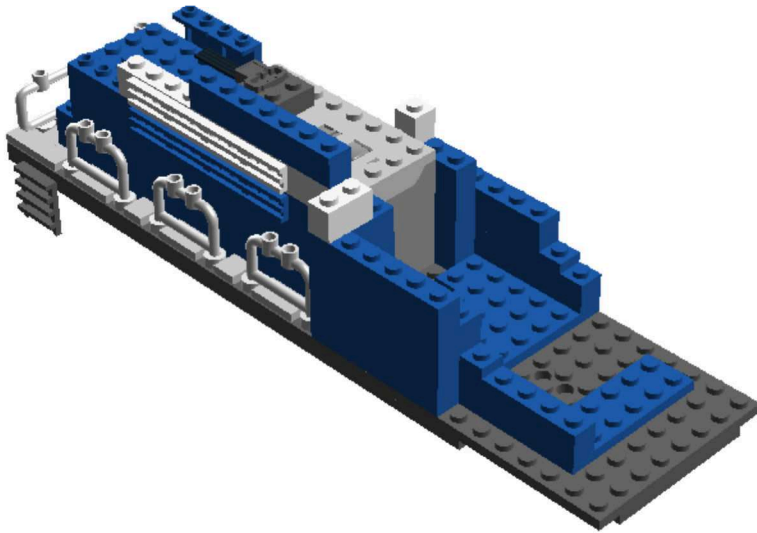

Step 47 of 142

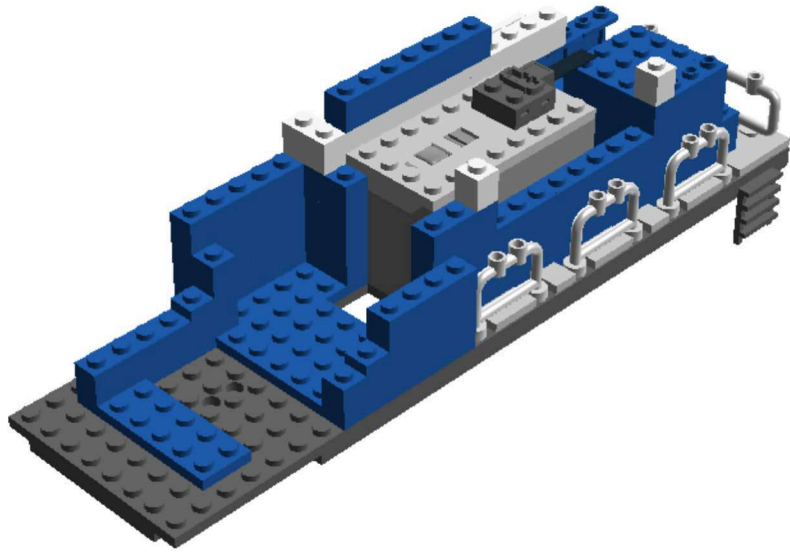

Step 48 of 142

1 x



2 x

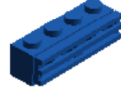

Step 49 of 142

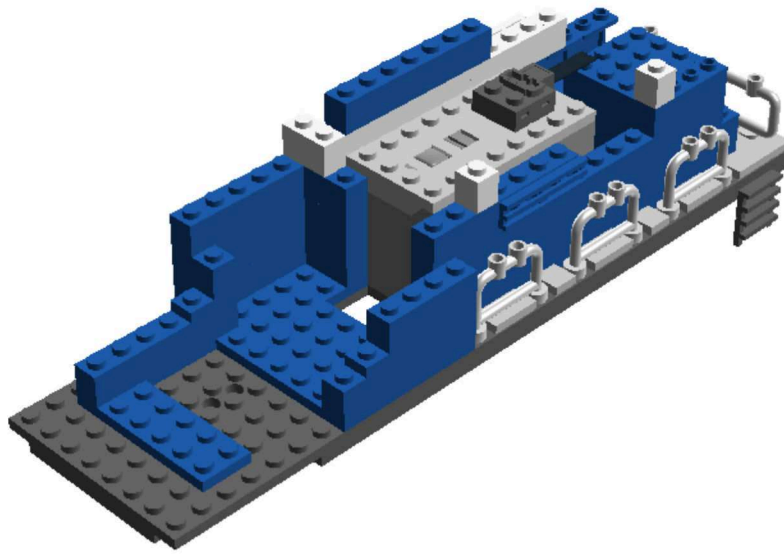

Step 50 of 142

1 x



2 x



Step 51 of 142

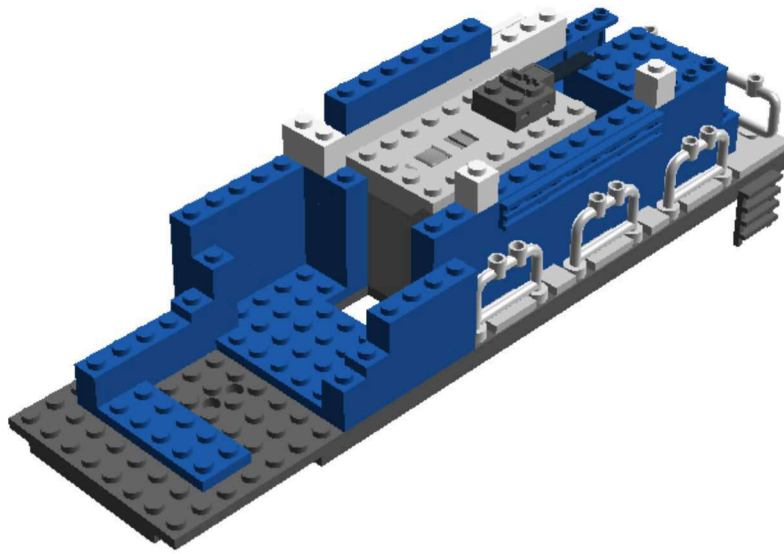

Step 52 of 142

1 x



2 x



Step 53 of 142

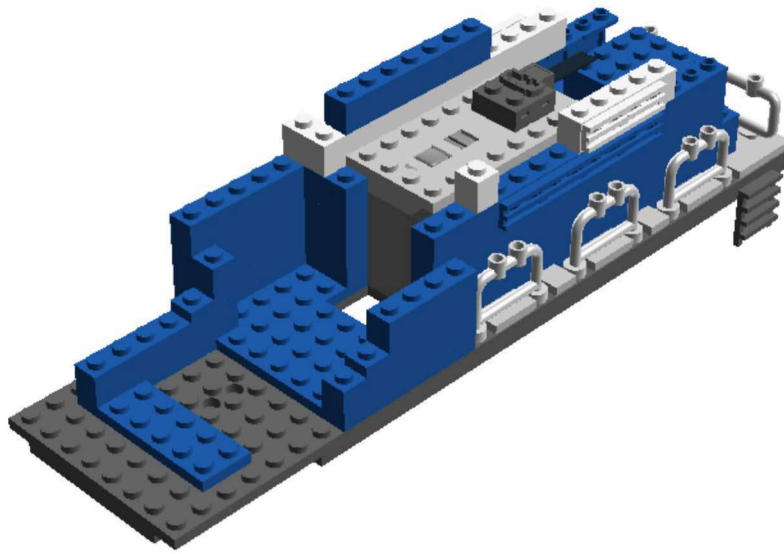

Step 54 of 142

1 x



2 x

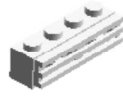

Step 55 of 142

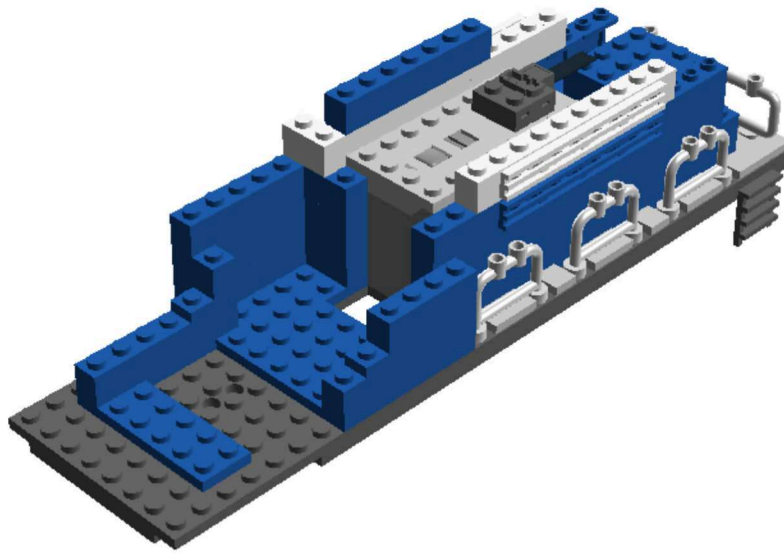

Step 56 of 142

1 x



2 x

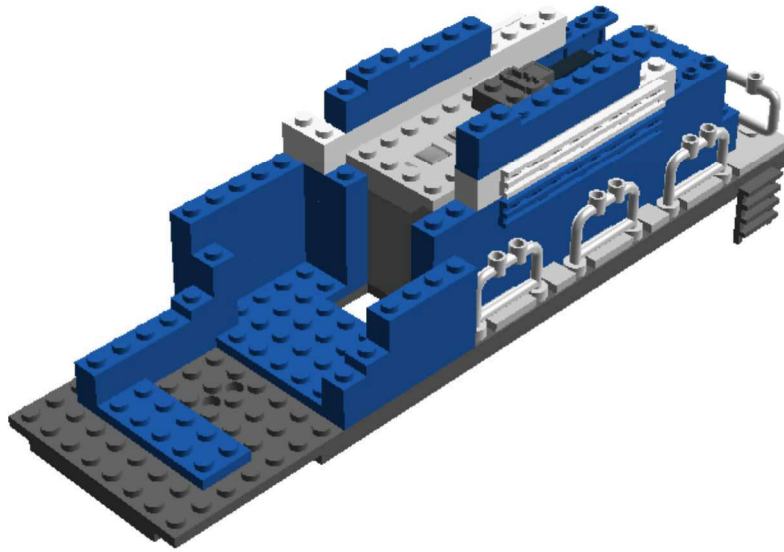

Step 57 of 142

1 x



1 x



1 x



1 x

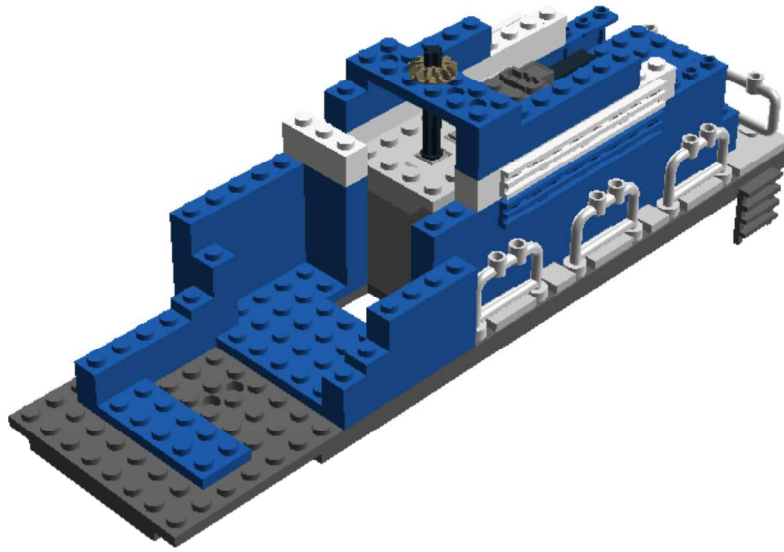

Step 58 of 142

1 x



1 x



2 x

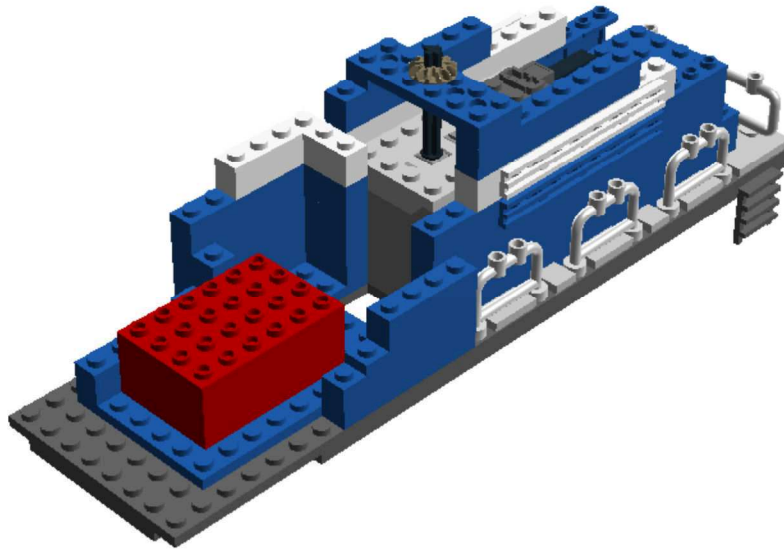

Step 59 of 142

1 x



1 x

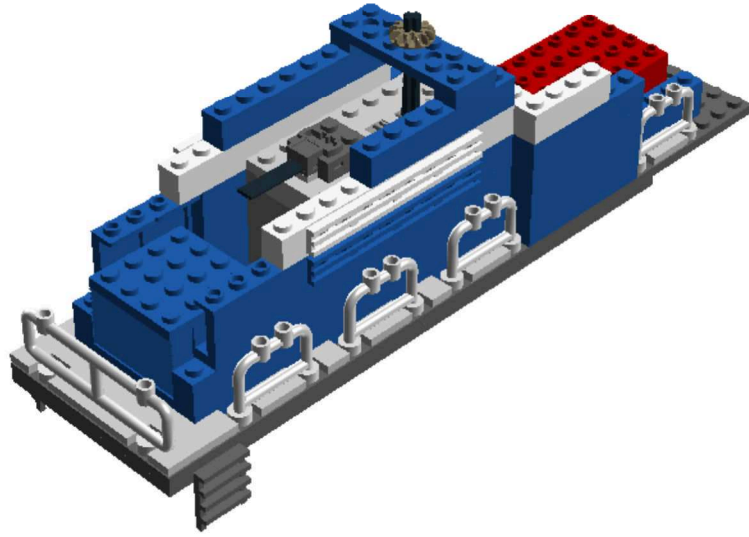

Step 60 of 142

1 x



1 x



1 x



1 x

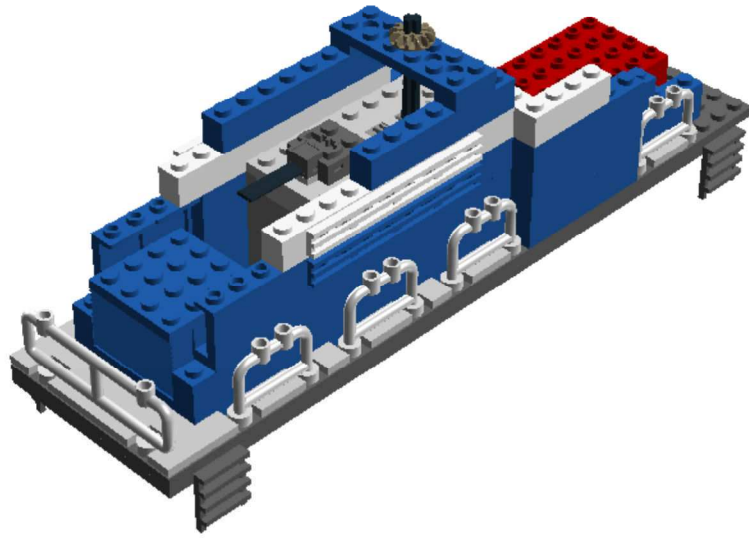

Step 61 of 142

1 x



1 x



1 x



1 x

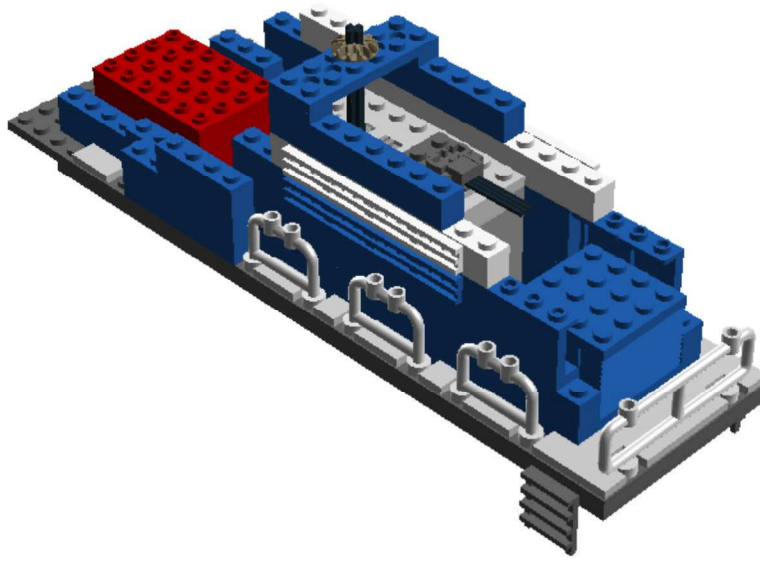

Step 62 of 142

1 x



1 x



1 x



1 x

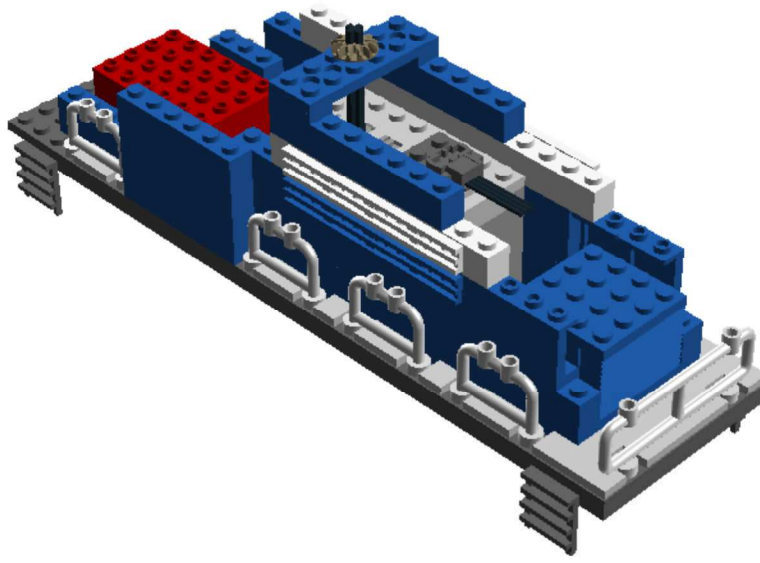

Step 63 of 142

1 x



1 x



1 x



1 x

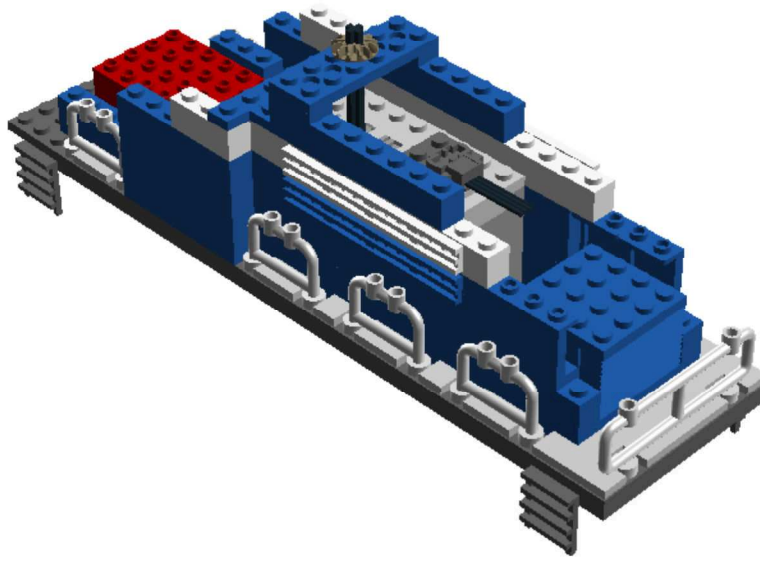

Step 64 of 142

2 x



1 x



1 x

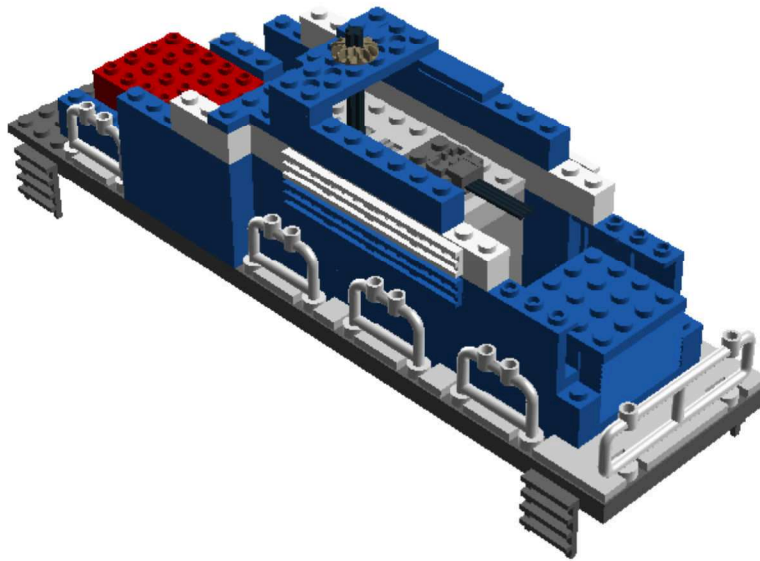

Step 65 of 142

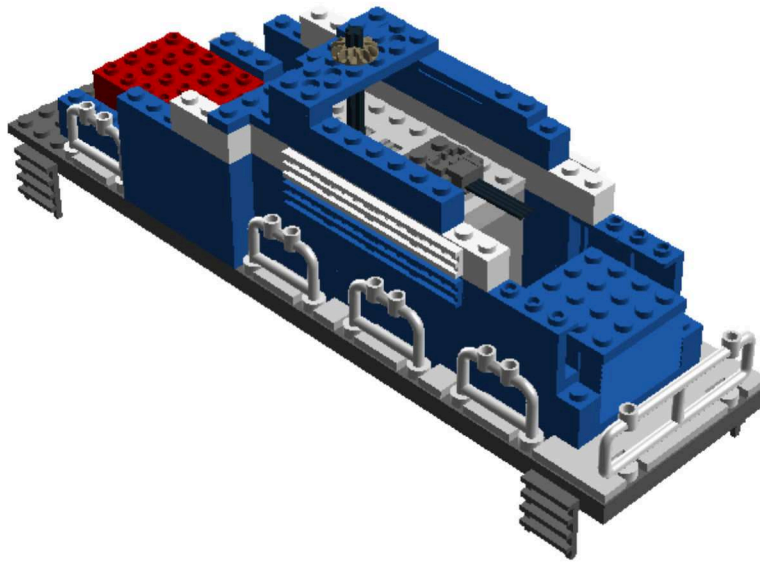

Step 66 of 142

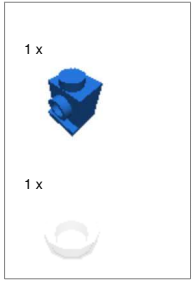

Step 67 of 142

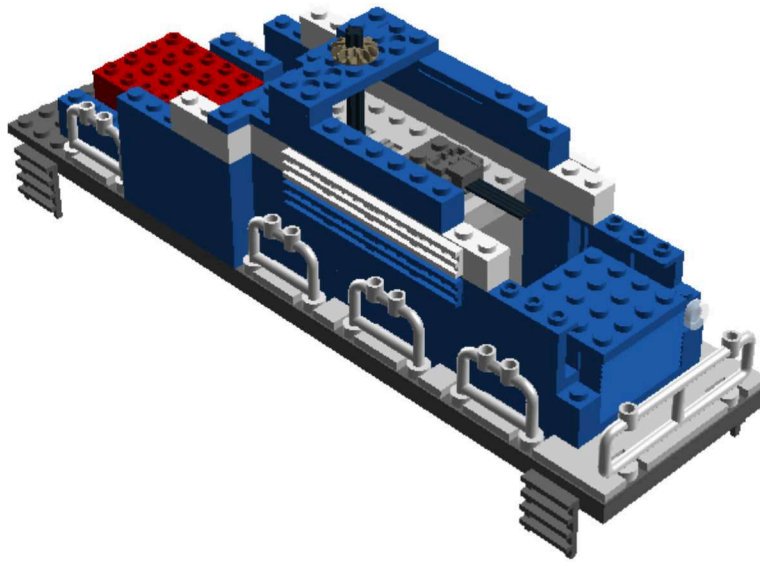

Step 68 of 142

1 x



1 x

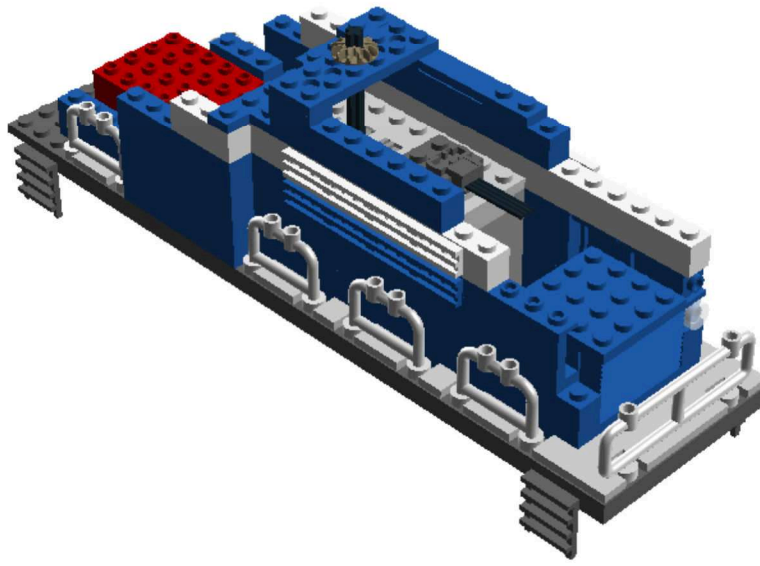

Step 69 of 142

1 x



1 x



Step 70 of 142

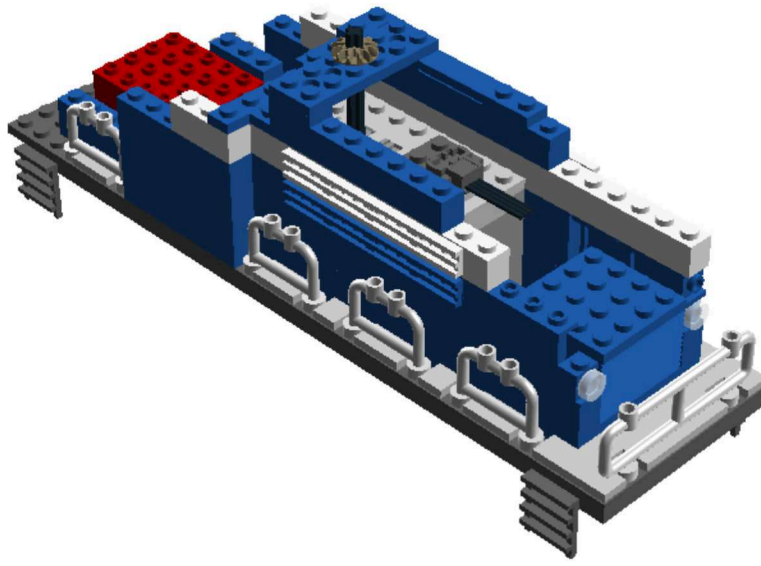

Step 71 of 142

1 x







1 x

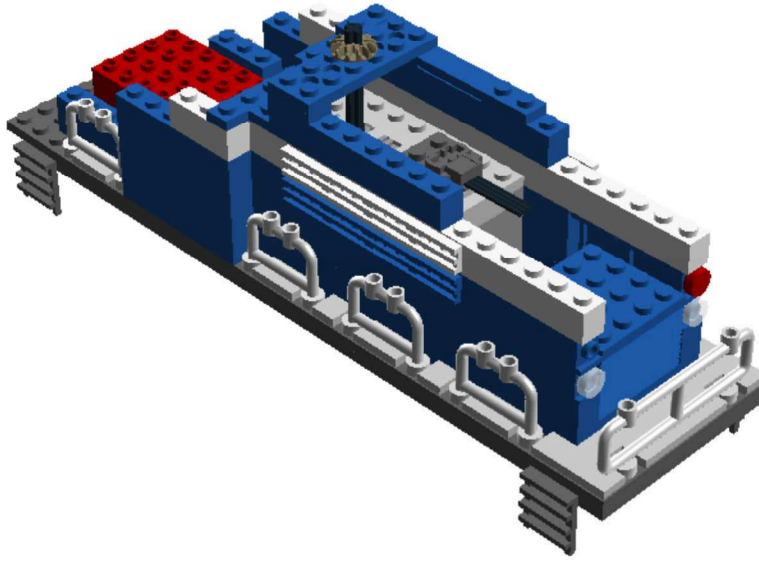

1 x



Step 72 of 142

- 1 x 
- 1 x 
- 1 x 
- 1 x 

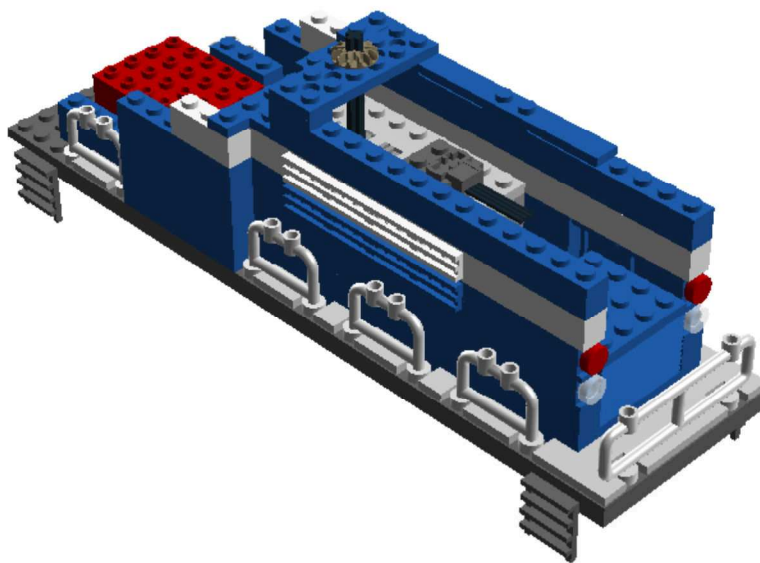

Step 73 of 142

3 x



1 x

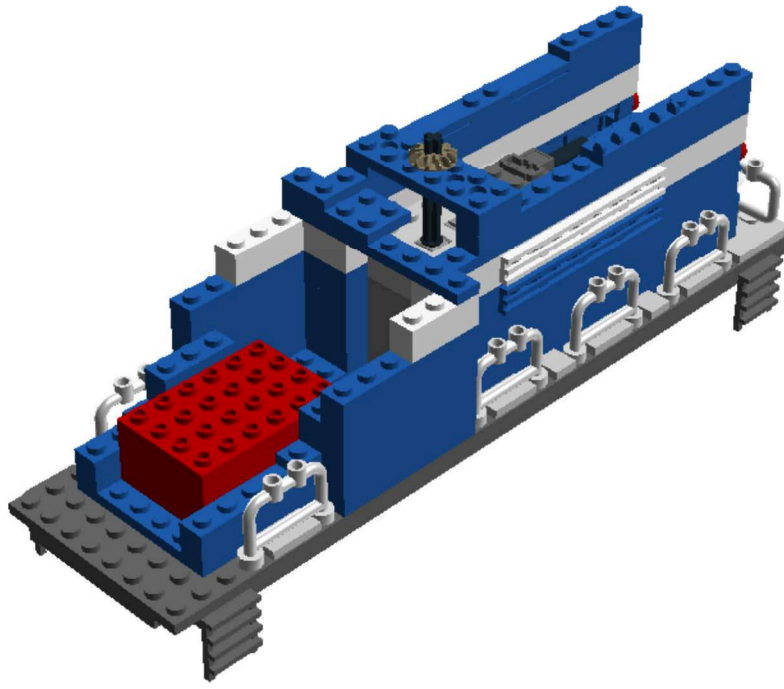

Step 74 of 142

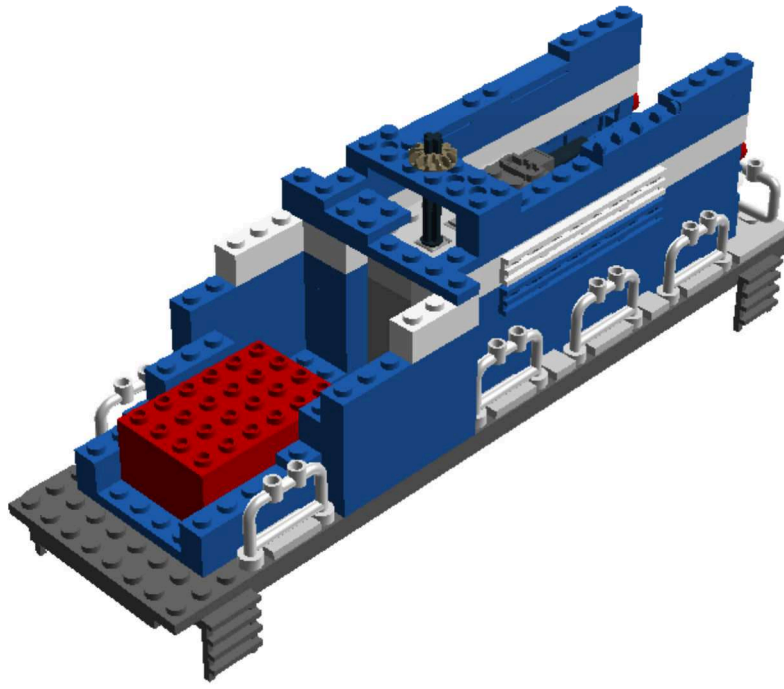
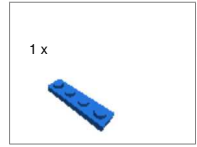

Step 75 of 142

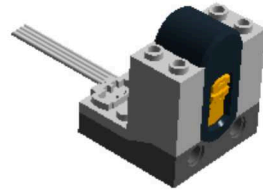

Step 76 of 142

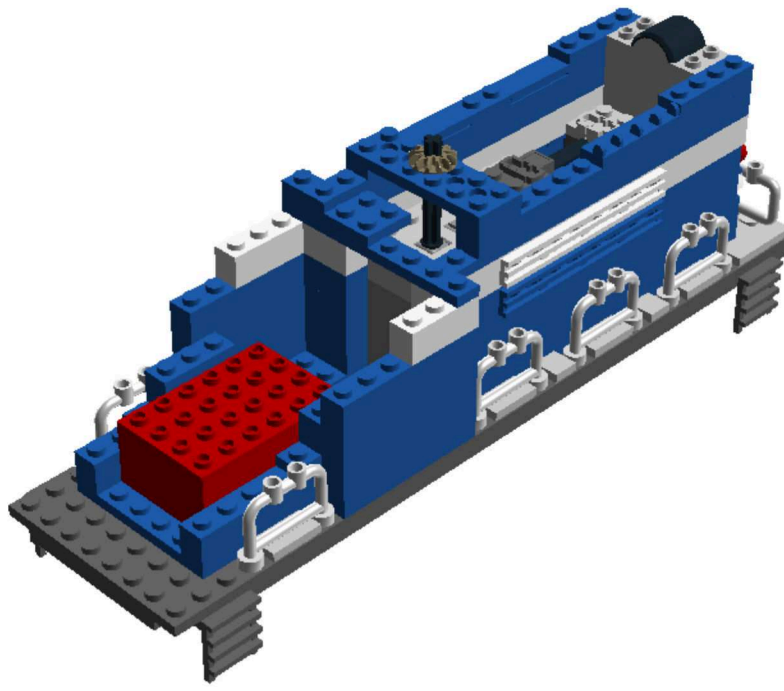

Step 77 of 142

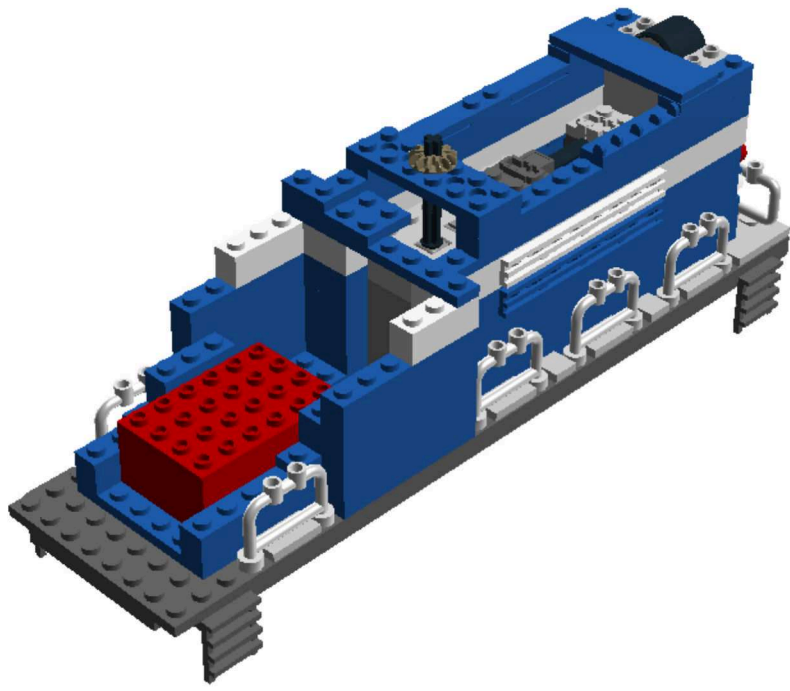
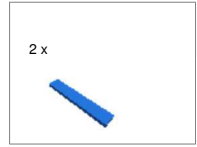

Step 78 of 142

2 x



1 x



1 x

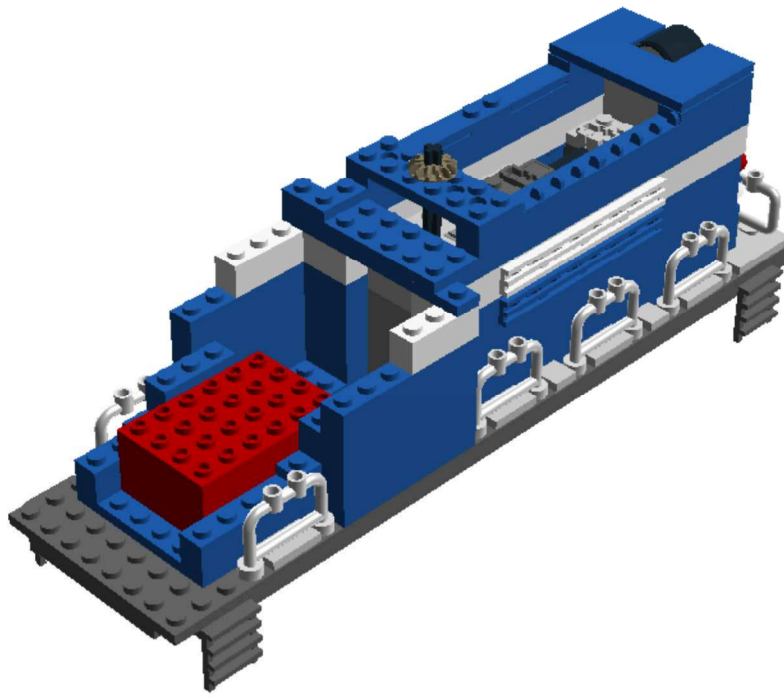

Step 79 of 142

1 x



1 x







1 x

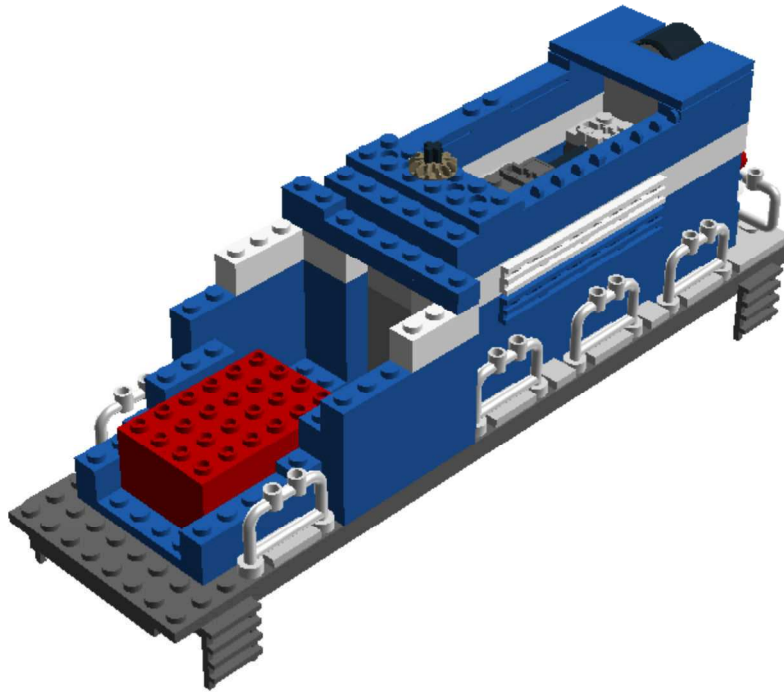

1 x





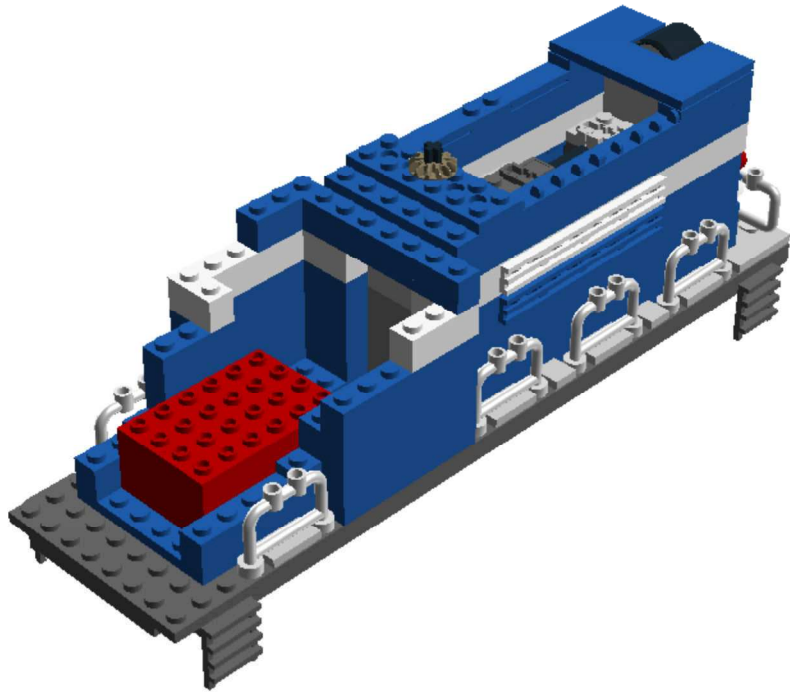

Step 80 of 142

- 1 x 
- 1 x 
- 1 x 
- 1 x 



Step 81 of 142

- 1 x 
- 1 x 
- 1 x 
- 1 x 

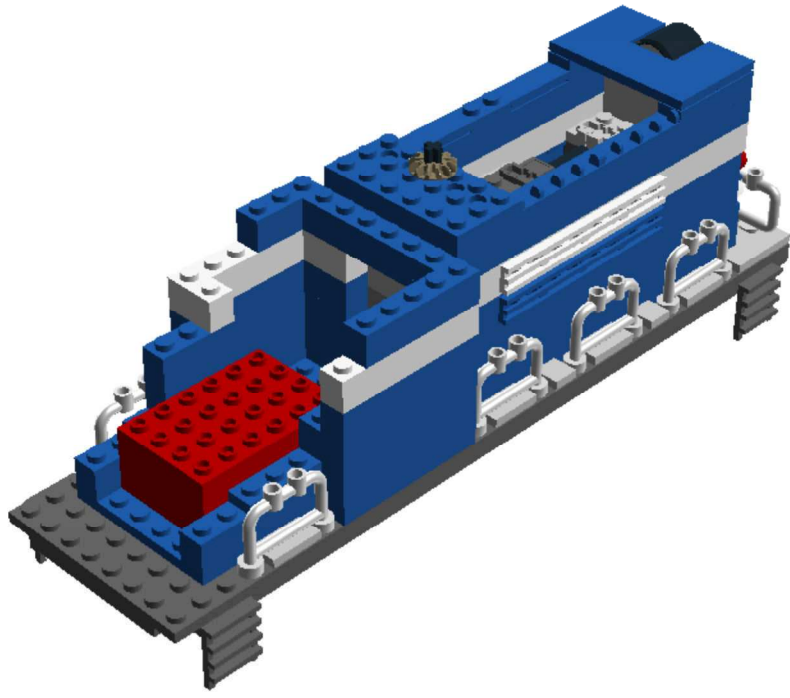

Step 82 of 142

1 x



1 x



2 x

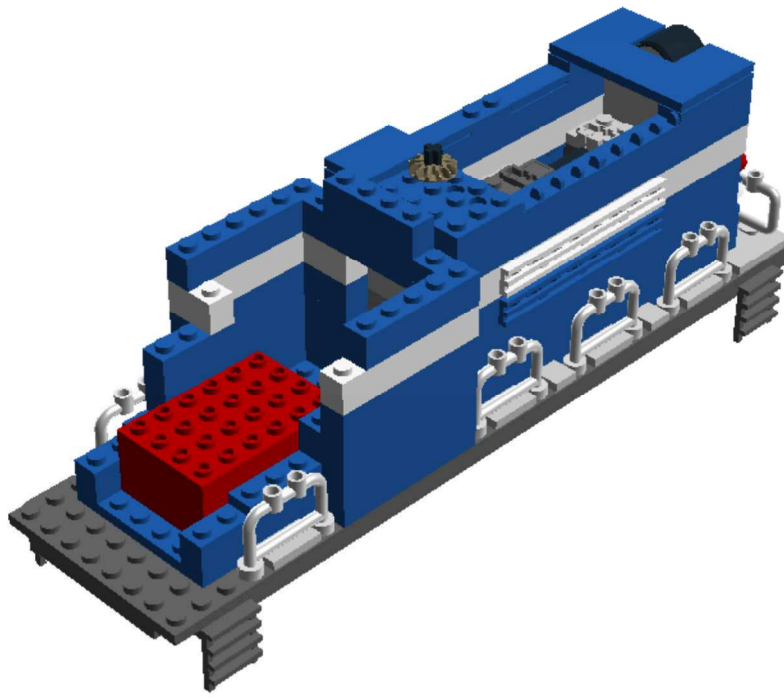

Step 83 of 142

1 x



1 x



1 x



1 x

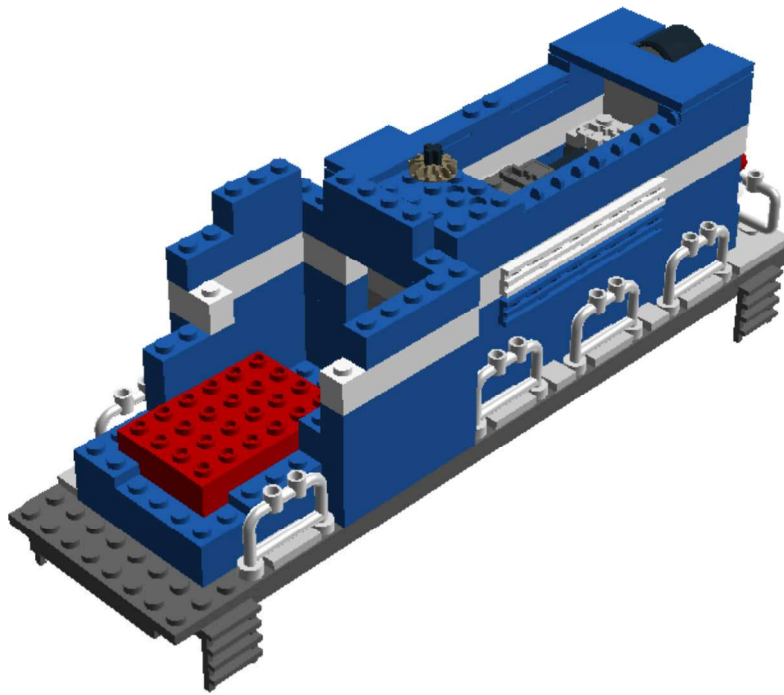

Step 84 of 142

1 x



1 x



2 x

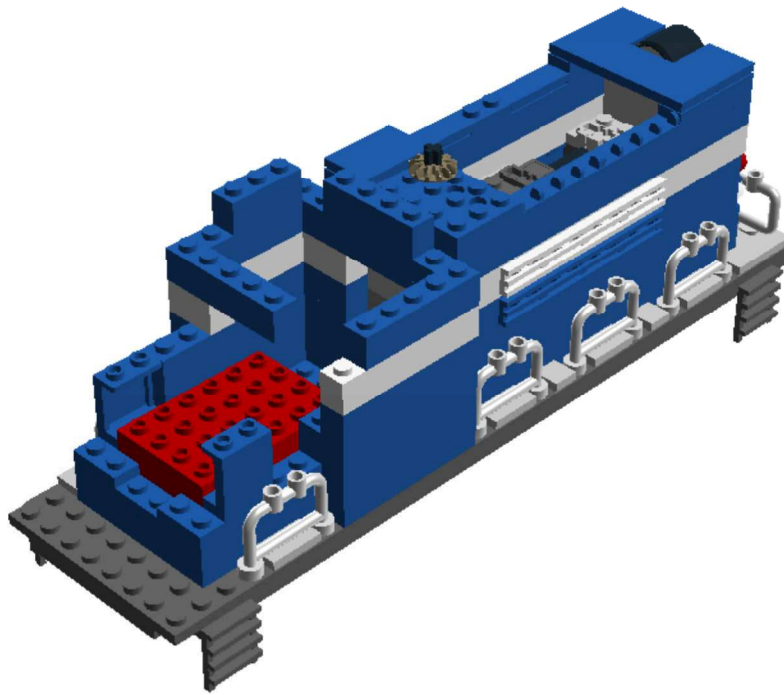

Step 85 of 142

2 x







1 x

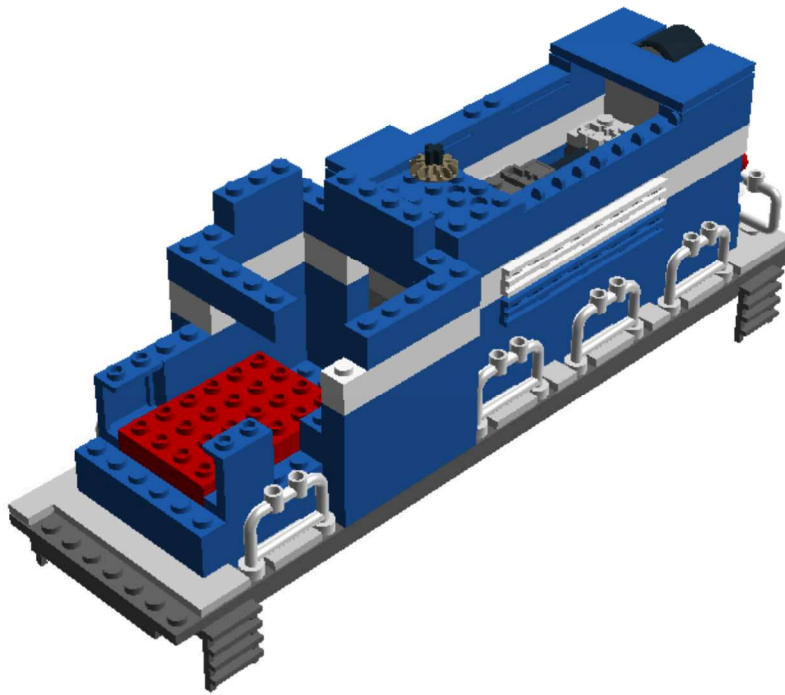

1 x



Step 86 of 142

- 1 x 
- 1 x 
- 1 x 
- 1 x 

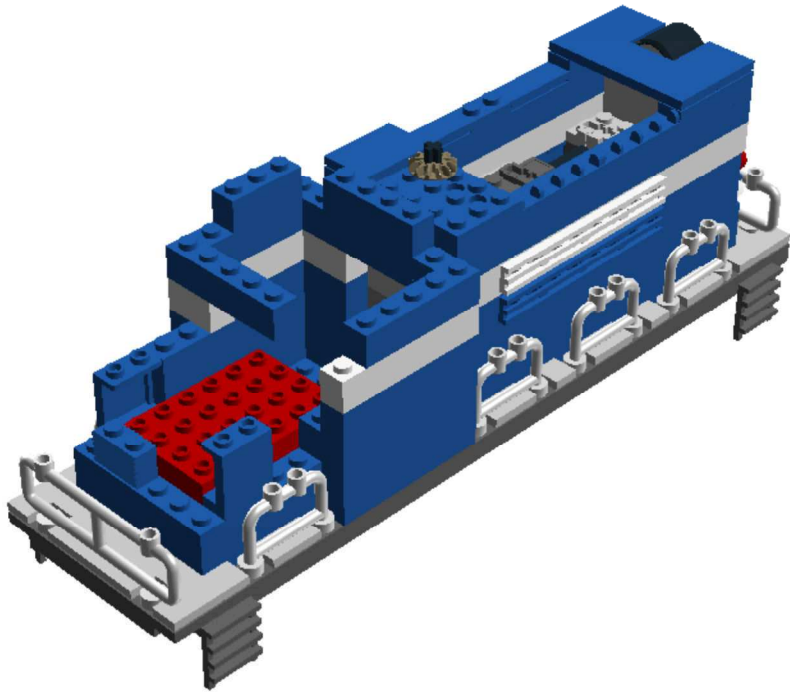

Step 87 of 142

1 x



1 x



1 x

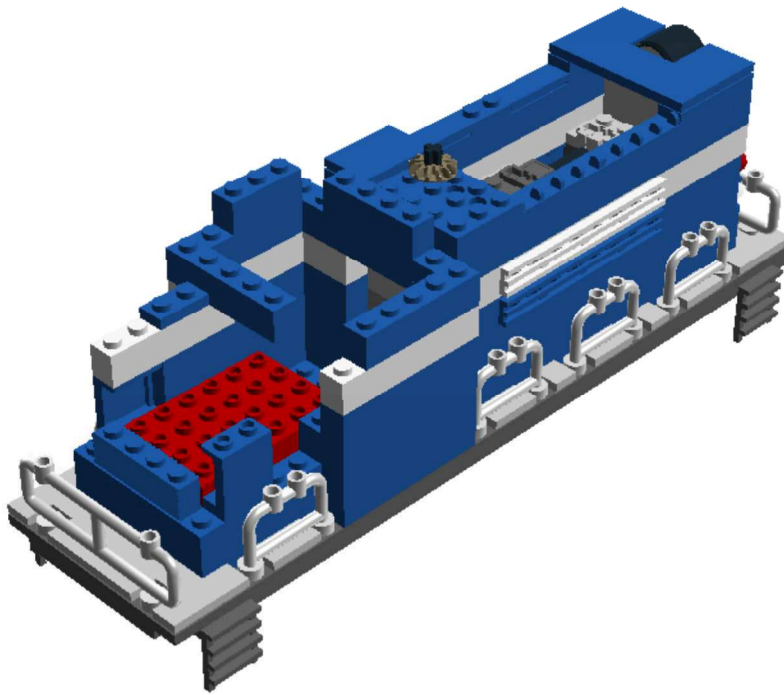

Step 88 of 142

1 x



1 x



1 x



1 x

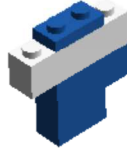

Step 89 of 142

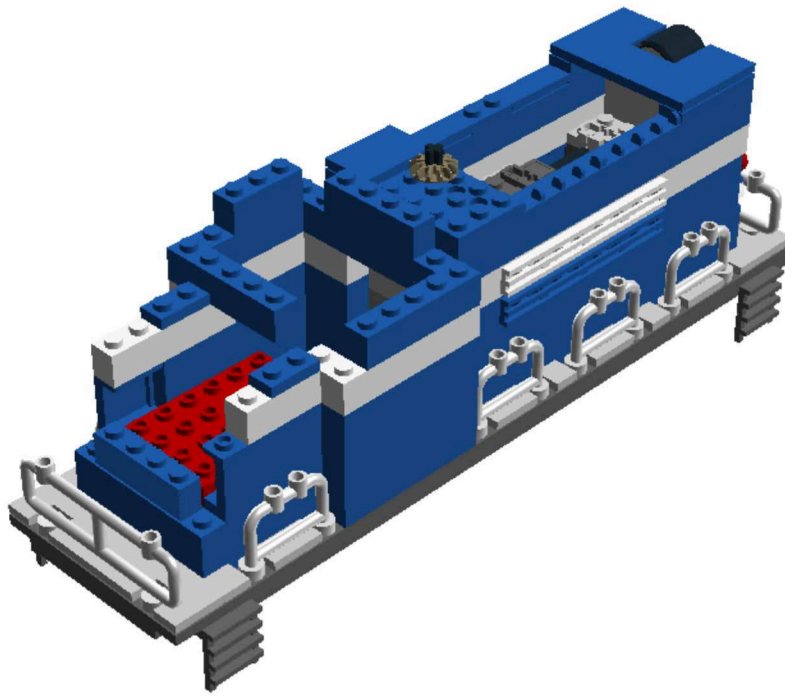

Step 90 of 142

1 x



1 x



1 x



1 x

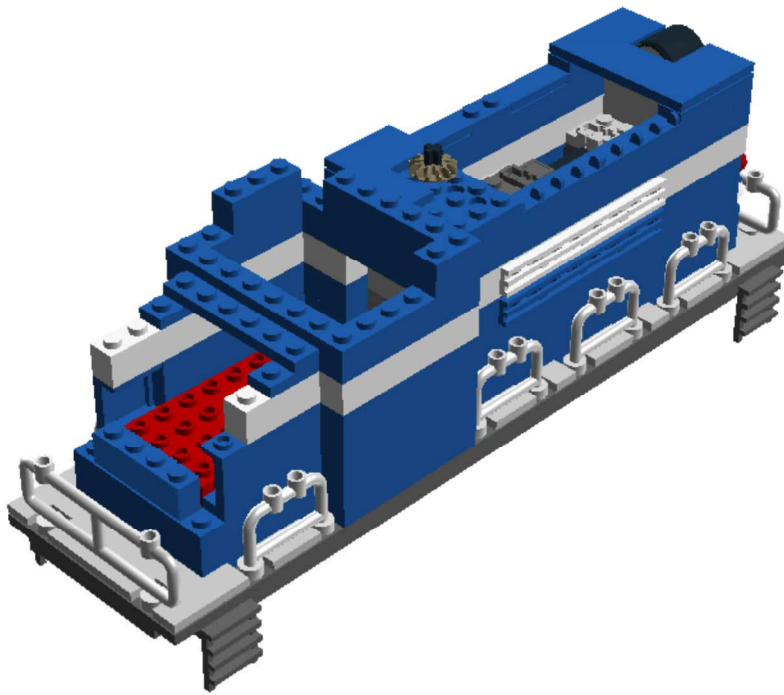

Step 91 of 142

1 x



2 x



1 x

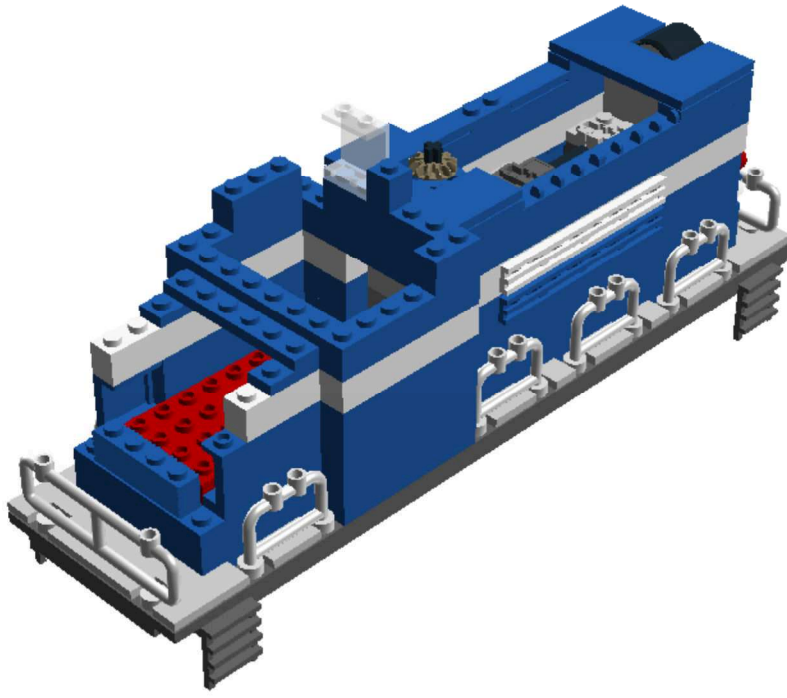

Step 92 of 142

1 x



1 x



1 x



1 x

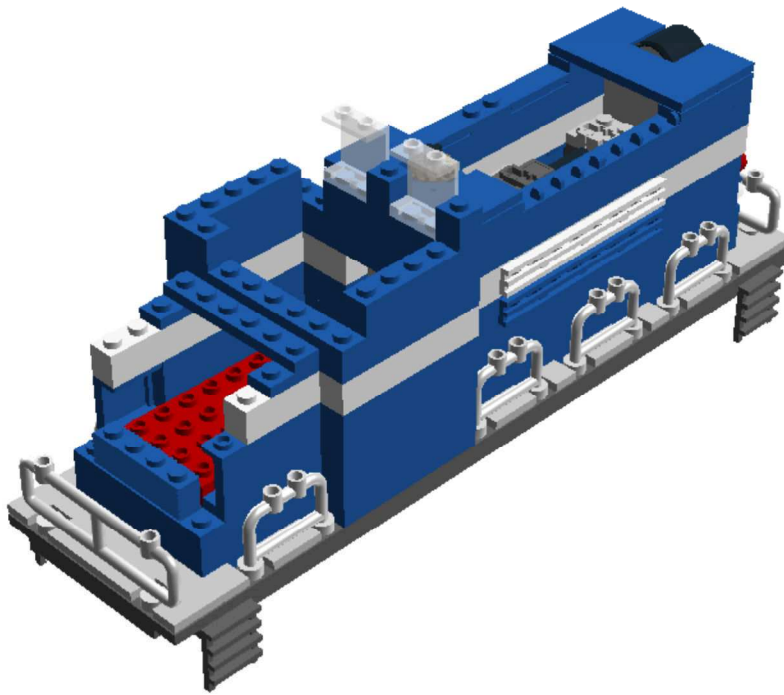

Step 93 of 142

2 x



1 x



1 x

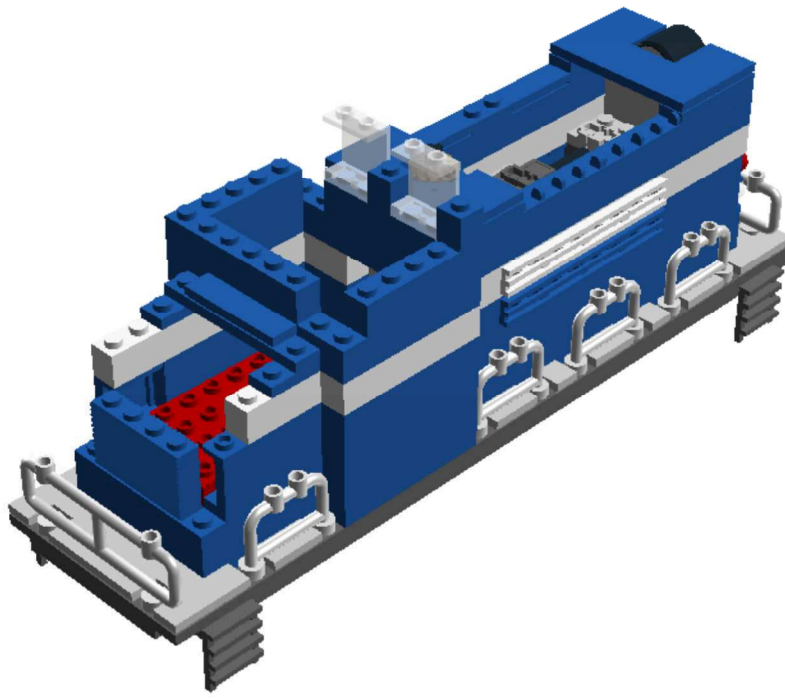

Step 94 of 142

1 x



1 x



Step 95 of 142

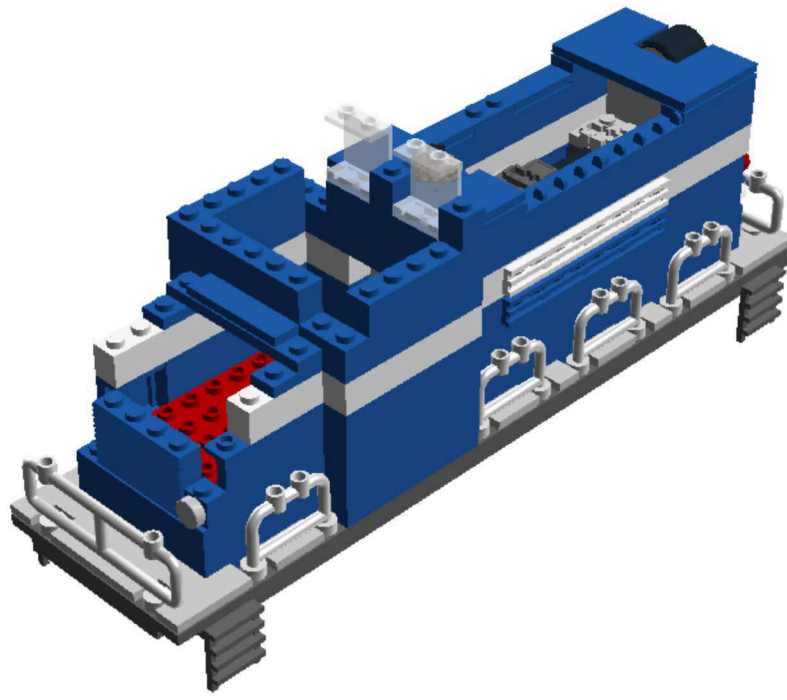

Step 96 of 142

1 x



1 x

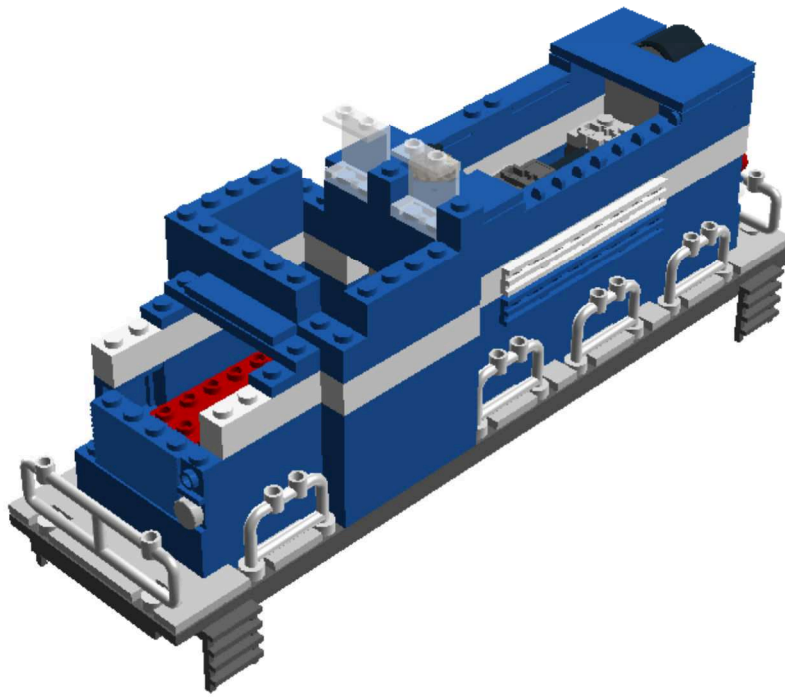

Step 97 of 142

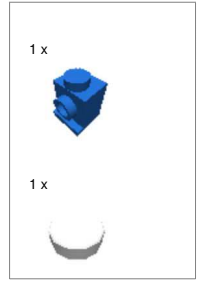

Step 98 of 142

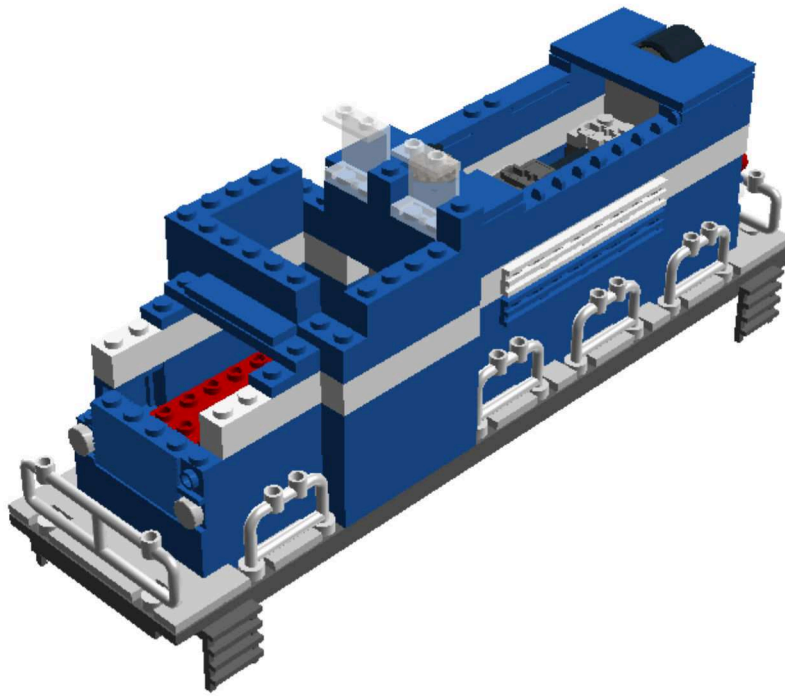

Step 99 of 142

1 x



1 x



Step 100 of 142

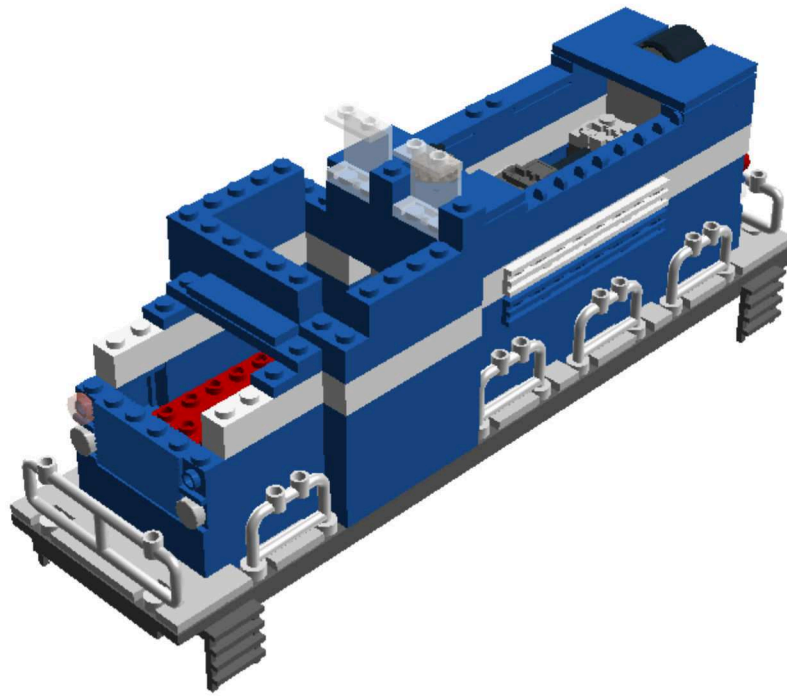

Step 101 of 142





1 x

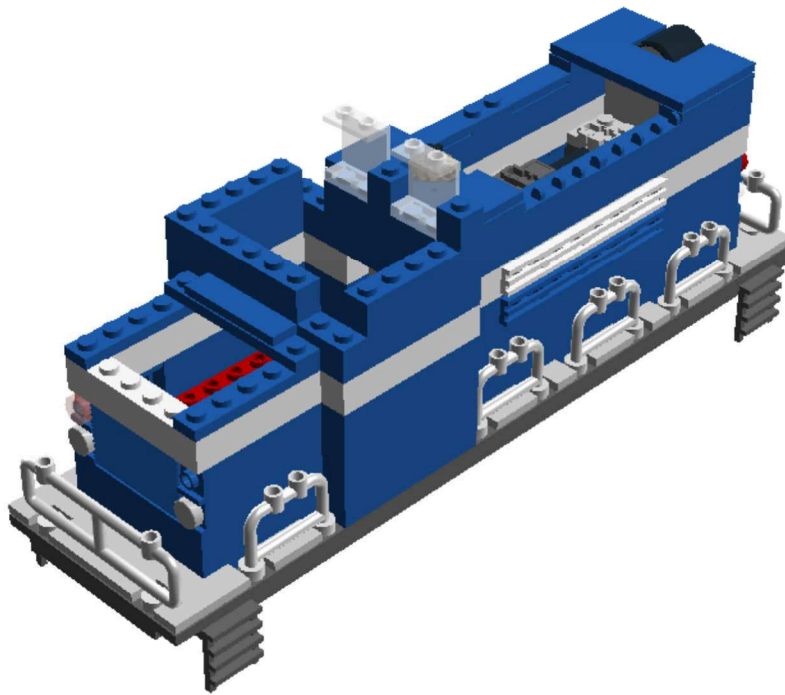

2 x



Step 102 of 142

- 1 x 
- 1 x 
- 1 x 
- 1 x 

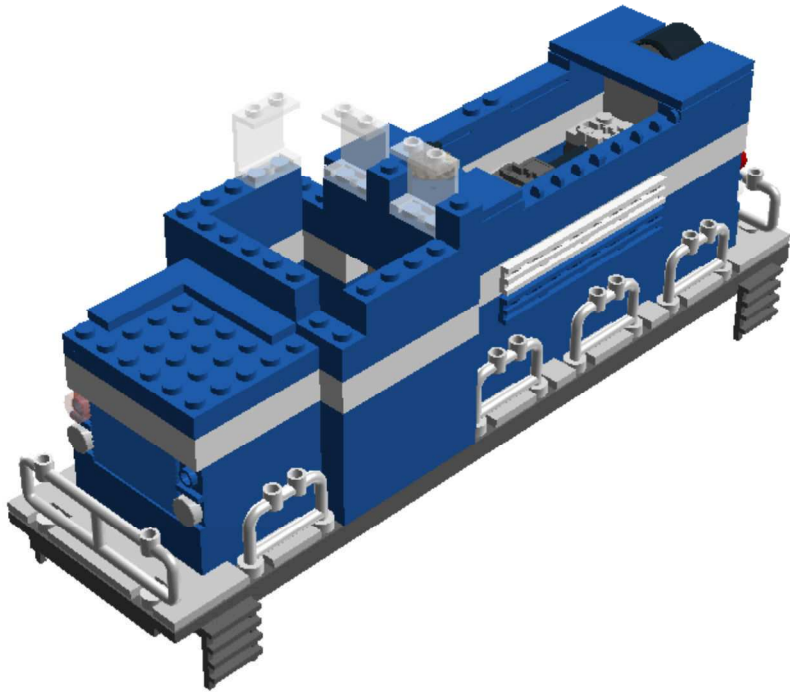

Step 103 of 142

2 x



2 x

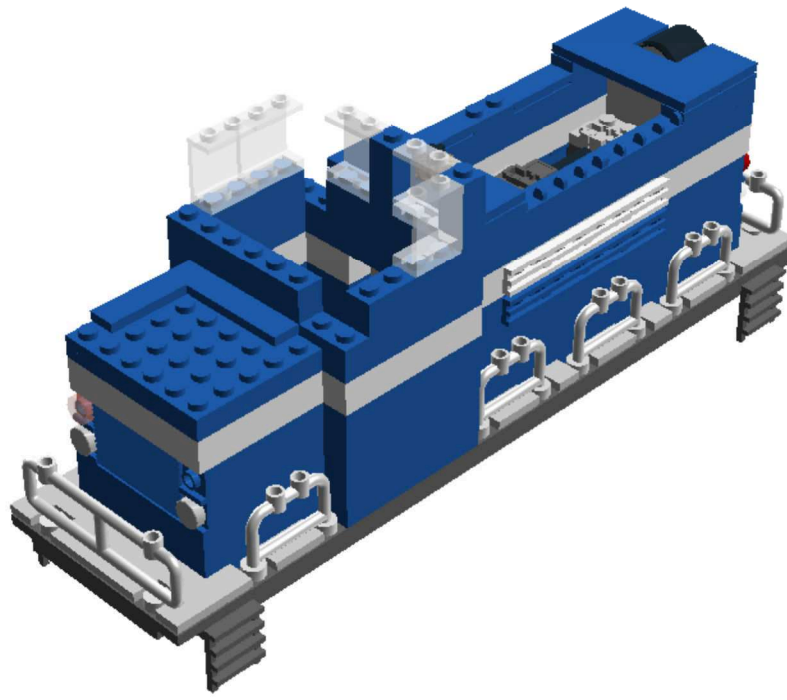

Step 104 of 142

2 x



2 x

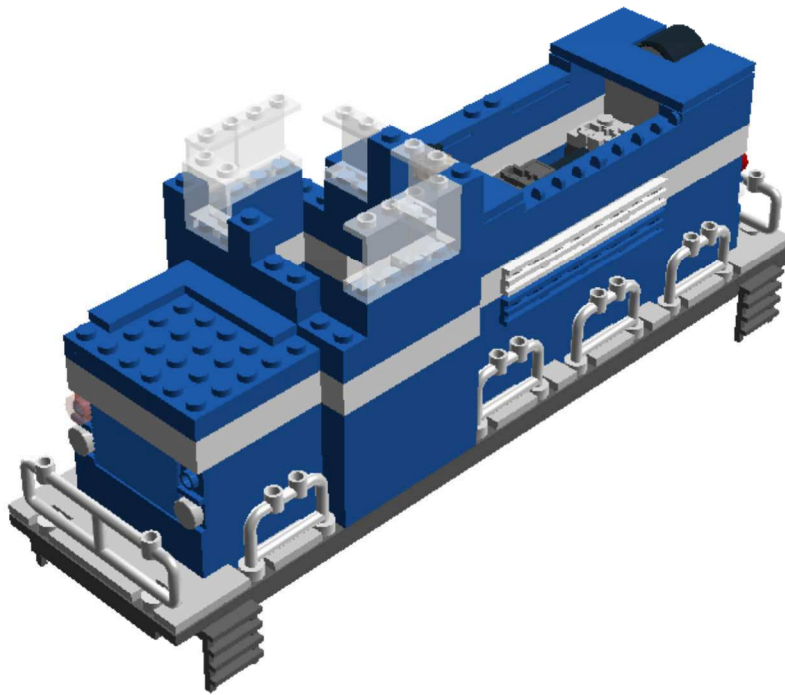

Step 105 of 142





3 x

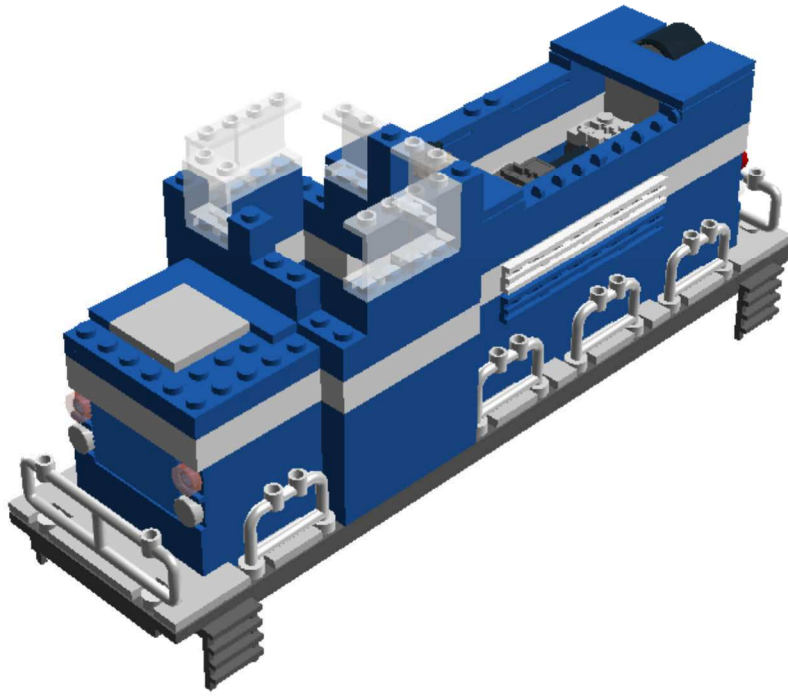

1 x



Step 106 of 142

- 1 x 
- 1 x 
- 1 x 
- 1 x 

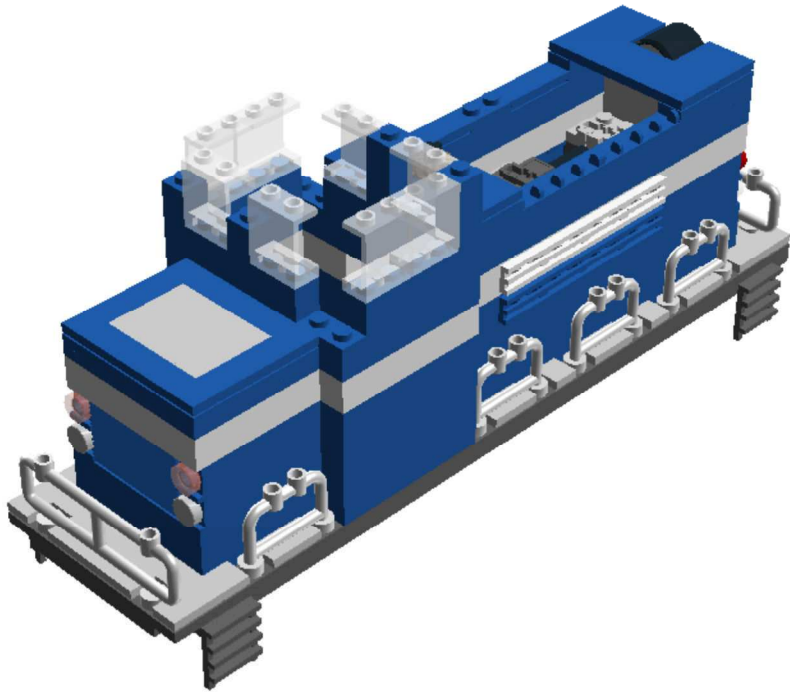

Step 107 of 142

2 x

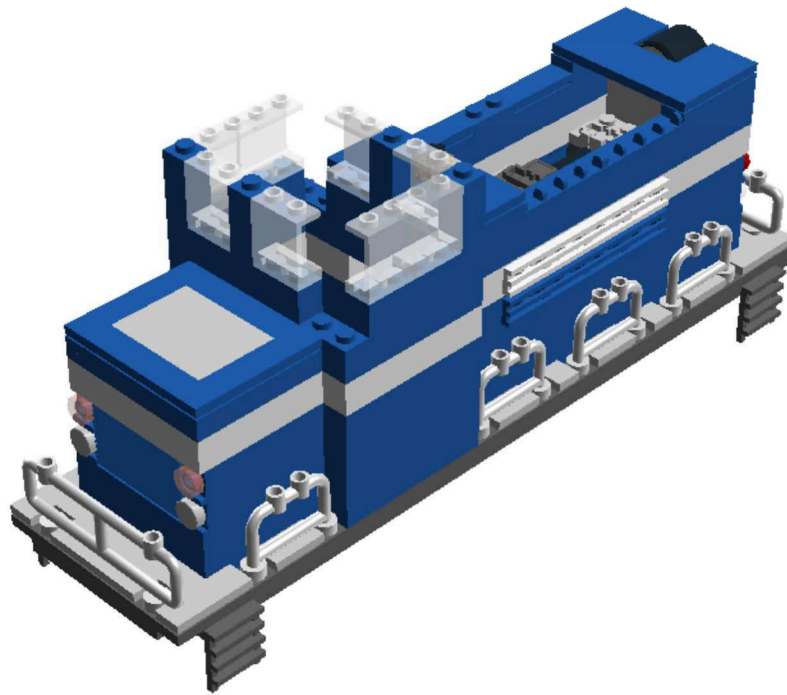

Step 108 of 142

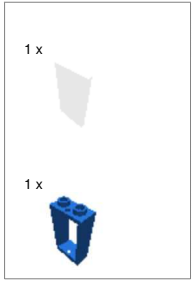

Step 109 of 142

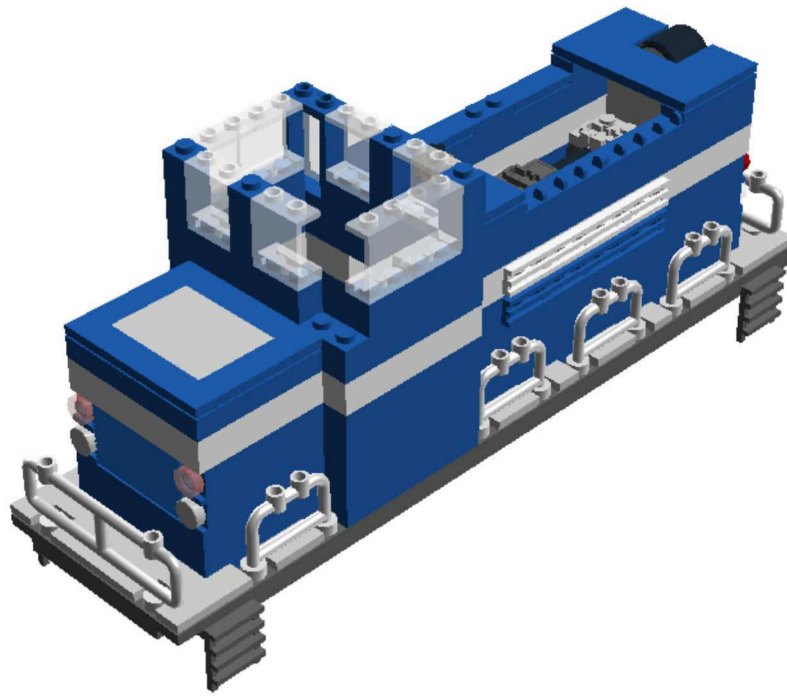

Step 110 of 142

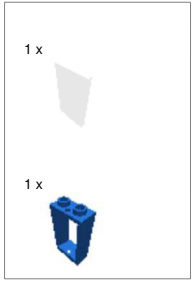

Step 111 of 142

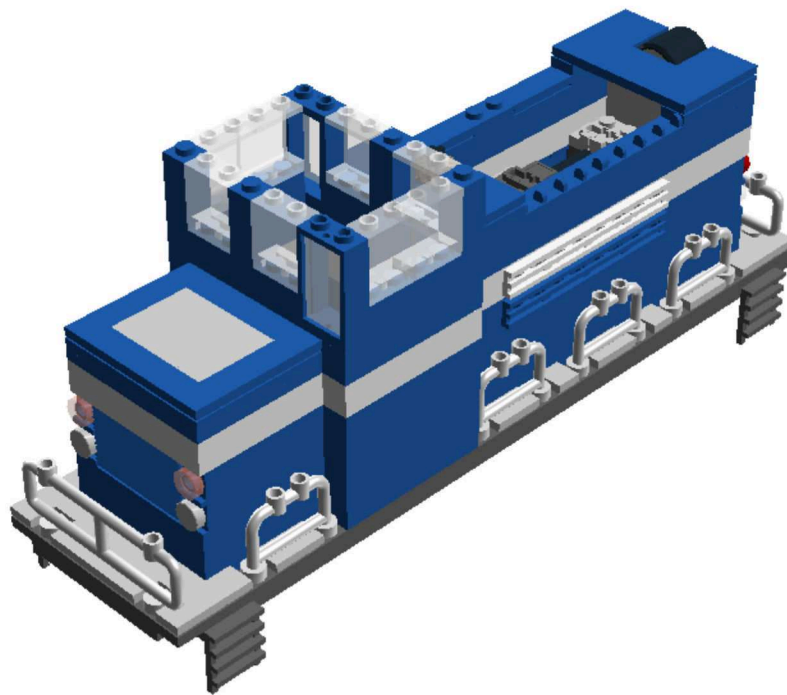

Step 112 of 142

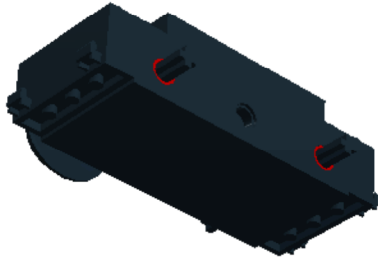

Step 113 of 142

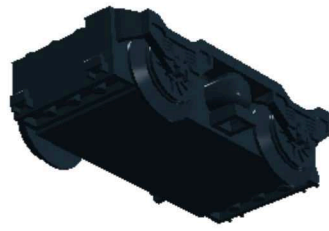
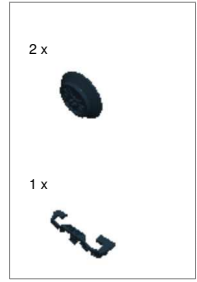

Step 114 of 142

1 x



1 x



1 x



1 x



Step 115 of 142

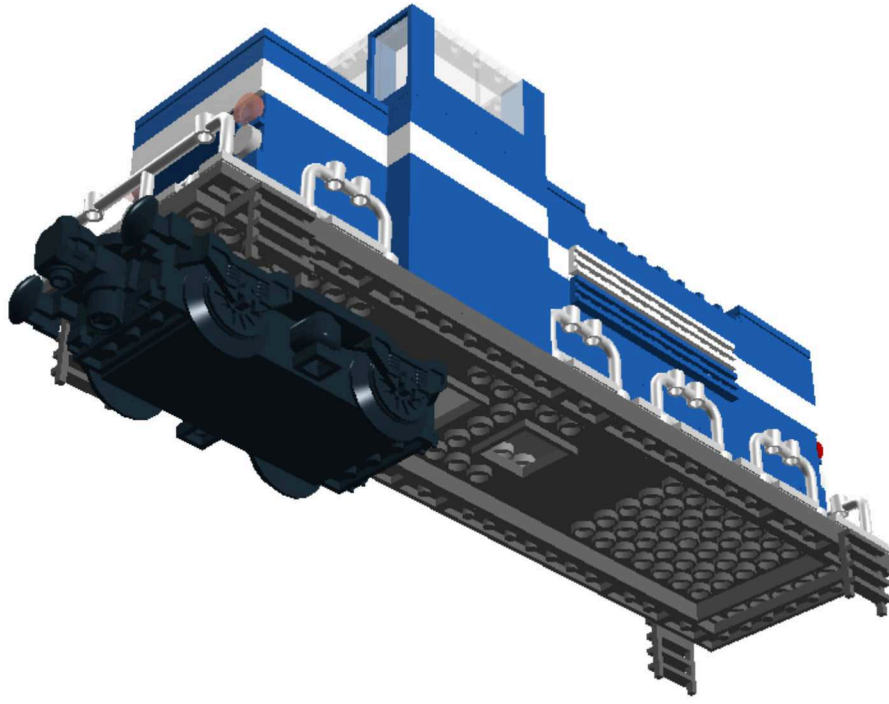

Step 116 of 142

1 x



1 x



1 x

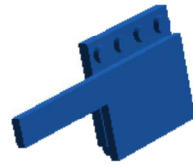

Step 117 of 142

3 x



1 x



Step 118 of 142

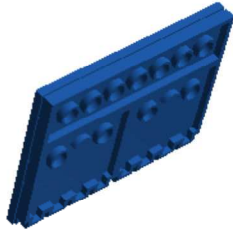
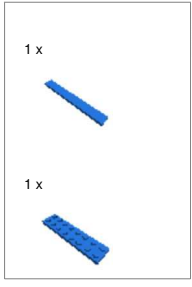

Step 119 of 142

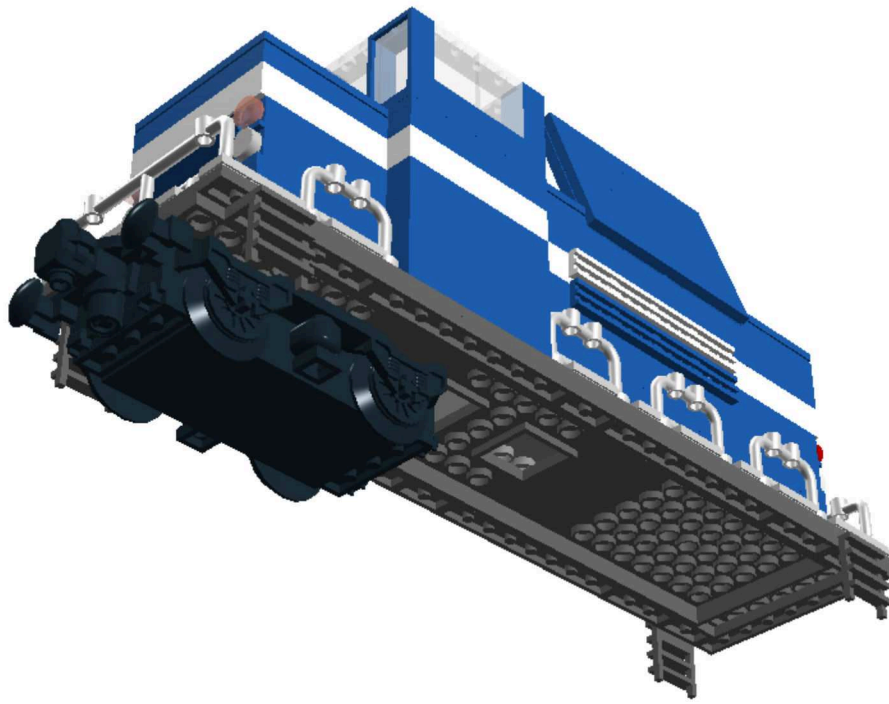

Step 120 of 142

1 x



1 x



1 x



1 x



Step 121 of 142

1 x



1 x



1 x



1 x

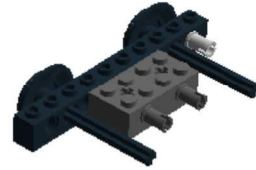

Step 122 of 142

2 x



1 x

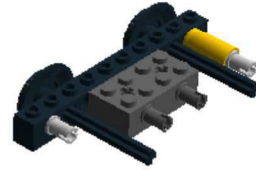

Step 123 of 142

1 x



1 x

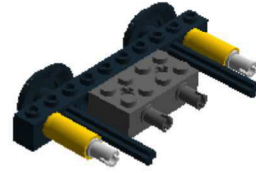

Step 124 of 142

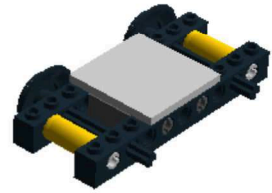
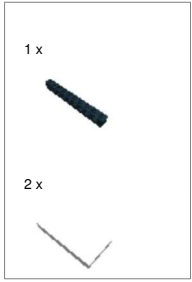

Step 125 of 142

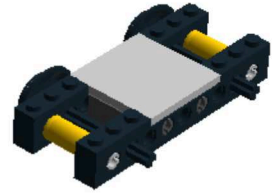

Step 126 of 142

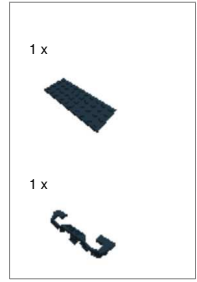

Step 127 of 142

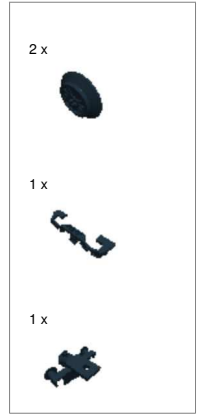

Step 128 of 142

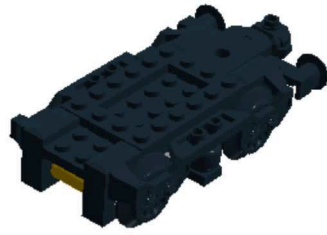

Step 129 of 142

1 x



1 x



Step 130 of 142



Step 131 of 142

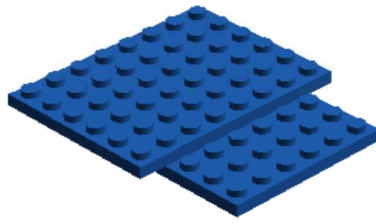
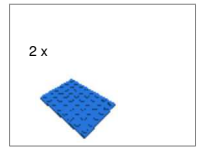

Step 132 of 142

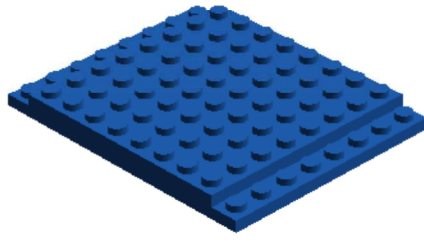
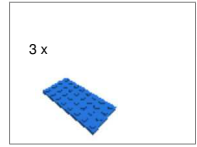

Step 133 of 142

1 x



1 x



1 x



1 x

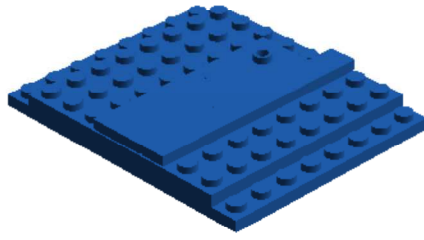

Step 134 of 142

2 x



1 x



1 x

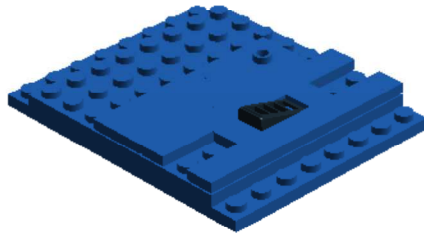

Step 135 of 142

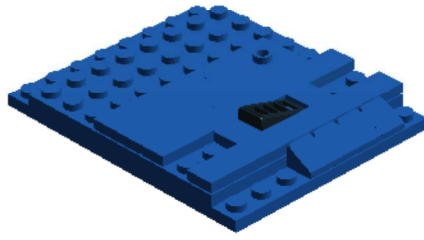
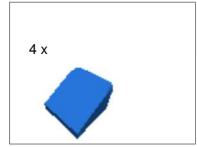

Step 136 of 142

1 x



1 x



1 x



1 x

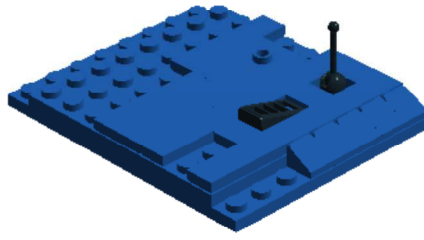

Step 137 of 142

1 x



1 x



1 x



1 x

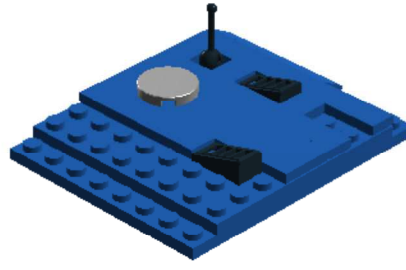

Step 138 of 142

3 x



1 x

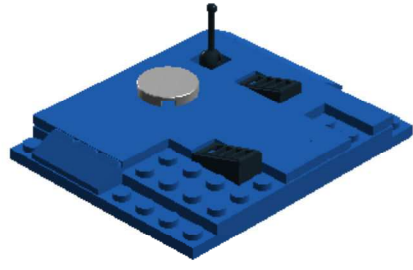

Step 139 of 142

3 x



1 x

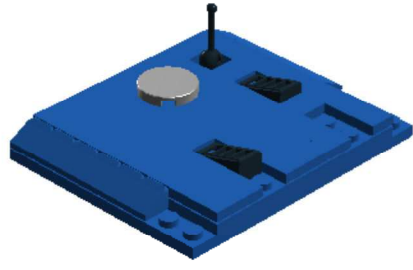

Step 140 of 142

3 x



1 x



Step 141 of 142

1 x



2 x













































1 x



Step 142 of 142



- | | | |
|--|--|--|
| 6 x  BRICK 1X1 - Weiss | 11 x  BRICK 1X1 - Klares Blau | 8 x  PROFILE BRICK 1X2 - Klares Blau |
| 1 x  BRICK 1X2 - Weiss | 7 x  BRICK 1X2 - Klares Blau | 2 x  BRICK 1X3 - Weiss |
| 13 x  BRICK 1X3 - Klares Blau | 3 x  BRICK CORNER 1X2X2 - Weiss | 6 x  BRICK CORNER 1X2X2 - Klares Blau |
| 4 x  BRICK 1X4 - Weiss | 12 x  BRICK 1X4 - Klares Blau | 1 x  BRICK 1X6 - Weiss |
| 7 x  BRICK 1X6 - Klares Blau | 1 x  BRICK 1X6 WITHOUT PINS - Klares Blau | 2 x  BRICK 2X4 - Klares Blau |
| 1 x  BRICK 1X8 - Klares Blau | 2 x  BRICK 1X12 - Klares Blau | 1 x  ROUND BRICK 1X1 - Tr. Gelb |
| 8 x  ANGULAR BRICK 1X1 - Klares Blau | 4 x  BRICK 1X4 W. 4 KNOBS - Weiss | 4 x  BRICK 1X4 W. 4 KNOBS - Klares Blau |
| 2 x  BEARING ELEMENT 2X2 W.D. SNAP - Dunkel Steingrau | 2 x  TECHNIC BRICK 1X10 Ø4.9 - Schwarz | 16 x  ROOF TILE 1X1X2/3, PC - Klares Blau |
| 2 x  ROOF TILE 1X3/25° - Klares Rot | 5 x  FLAT TILE 1X1 - Klares Blau | 12 x  FLAT TILE 1X1 - Helles Steingrau |
| 4 x  PLATE 1X1 - Klares Blau | 8 x  RADIATOR GRILLE 1X2 - Weiss | 8 x  RADIATOR GRILLE 1X2 - Klares Blau |
| 3 x  FLAT TILE 1X2 - Klares Blau | 8 x  FLAT TILE 1X2 - Helles Steingrau | 11 x  PLATE 1X2 - Klares Blau |
| 2 x  PLATE 1X2 - Dunkel Steingrau | 1 x  PLATE 1X2 W. 1 KNOB - Klares Blau | 6 x  FLAT TILE 1X3 - Klares Blau |
| 4 x  FLAT TILE 1X3 - Helles Steingrau | 4 x  FLAT TILE 1X4 - Klares Blau | 2 x  FLAT TILE 1X4 - Helles Steingrau |
| 2 x  FLAT TILE 2X2 - Klares Blau | 11 x  PLATE 1X3 - Klares Blau | 4 x  PLATE 1X3 - Schwarz |

4 x  PLATE 1X3 - Dunkel Steingrau

6 x  CORNER PLATE 1X2X2 - Klares Blau

1 x  PLATE 2X2 - Klares Blau

9 x  PLATE 1X4 - Klares Blau

4 x  PLATE 1X4 - Schwarz

3 x  FLAT TILE 1X6 - Klares Blau

1 x  PLATE 2X2 W 1 KNOB - Klares Blau

4 x  FLAT TILE 1X8 - Klares Blau

2 x  FLAT TILE 1X8 - Helles Steingrau

7 x  FLAT TILE 2X4 - Klares Blau

2 x  FLAT TILE 2X4 - Helles Steingrau

3 x  PLATE 2X3 - Klares Blau

10 x  PLATE 1X6 - Klares Blau

2 x  PLATE 1X8 - Klares Blau

5 x  PLATE 1X8 - Dunkel Steingrau

6 x  PLATE 1X10 - Dunkel Steingrau

2 x  PLATE 2X6 - Klares Blau

1 x  PLATE 2X6 - Dunkel Steingrau

1 x  PLATE 4X4 - Klares Blau

1 x  PLATE 2X8 - Klares Blau

1 x  PLATE 4X6 - Klares Blau

4 x  PLATE 4X8 - Klares Blau

1 x  PLATE 4X10 - Schwarz

2 x  PLATE 6X8 - Klares Blau

2 x  FLAT TILE 1X1, ROUND - Klares Rot

2 x  FLAT TILE 1X1, ROUND - Transparent

2 x  FLAT TILE 1X1, ROUND - Tr. Rot

2 x  FLAT TILE 1X1, ROUND - Helles Steingrau

1 x  FLAT TILE 2X2, ROUND - Silber Metallic

2 x  PLATE 1X4 VERTICAL HINGE - Klares Blau

2 x  PLATE 2X4, 3XØ4.9 - Schwarz

1 x  PLATE 2X6 W. HOLES - Klares Blau

2 x  ROOF 4X4 W. HINGE - Klares Blau

2 x  GLASS FOR FRAME 1X2X3 - Transparent

8 x  WALLELEMENT 1X2X2 - Transparent

6 x  WALLELEMENT 1X2X2 - Klares Blau

2 x  FRAME 1X2X3 - Klares Blau

1 x  Train motor 2006 - Klares Rot,Schwarz

1 x  FUNC. BATTERY BOX 4x8x4 AAA - Mittel Steingrau,Helles Steingrau

2 x  FUNC. IR/RX 2 OUT. 4X4X4 - Schwarz,Flammend Gelb Orange,Dunkel Steingrau,Helles Steingrau

4 x  CONNECTOR PEG - Helles Steingrau

2 x  TUBE Ø7,84 2M - Klares Gelb

4 x  CROSS AXLE 6M - Schwarz

1 x  CROSS AXLE 4M WITH END STOP - Schwarz

1 x  CONICAL WHEEL Z12 - Gelb Sandfarbe

1 x  MINI ANTENNA - Schwarz

2 x  ROOF TILE W. LATTICE 1x2x2/3 - Schwarz

4 x  LADDER 1X2X2 - Dunkel Steingrau

8 x  HANGER 1X4X2 W. 2 CORED KNOBS - Silber Metallic

2 x  BALUSTRADE 1X8X2 - Silber Metallic

8 x  TRAIN WHEEL W/O-RING - Schwarz

1 x  BOGIE PLATE 4X6 - Schwarz

4 x  MOTORBOGIE, ORNAMENT - Schwarz

2 x  TRAIN BUFFER 2 - Schwarz

1 x  CHASSIS 6X28X6.4 - Dunkel Steingrau

2 x  COUNTERWEIGHT - Klares Rot